



AreaRAE Plus & AreaRAE Pro

User's Guide



Product Registration

Register your product online by visiting:

<http://www.raesystems.com/support/product-registration>

By registering your product, you can:

- Receive notification of product upgrades or enhancements
- Be alerted to Training classes in your area
- Take advantage of RAE Systems special offers and promotions

IMPORTANT! BUMP TEST THE MONITOR BEFORE EACH DAY'S USE

Prior to each day's use, every gas detection monitor should be bump tested to confirm the response of all sensors and activation of all alarms by exposing the monitor to a concentration of target gas that exceeds the low alarm set point. A bump test is also recommended if the monitor has been subjected to physical impact, liquid immersion, an Over Limit alarm event, or custody changes, or anytime the monitor's performance is in doubt.

To ensure greatest accuracy and safety, only bump test and calibrate in a fresh air environment.

The monitor should be calibrated every time it does not pass a bump test, but no less frequently than every six months, depending on use and exposure to gas and contamination, and its operational mode.

- Calibration intervals and bump test procedures may vary due to national legislation.
- Honeywell recommends using calibration gas cylinders containing the gas that is appropriate to the sensor you are using, and in the correct concentration.

AreaRAE Plus & AreaRAE Pro User's Guide

Contents

1	Features Comparison	15
2	Standard Contents	16
3	General Information.....	17
3.1	Key Features	18
4	Connections	19
5	User Interface.....	20
5.1	Display Overview	20
5.1.1	Status Indicator Icons	20
5.1.2	Status Indicator Icons For Instruments Equipped with ISM Radio or Wi-Fi.....	22
5.2	Keys And Interface	23
5.2.1	Reverse Direction.....	23
5.3	Screen Display For Various Numbers Of Active Sensors	24
5.4	Glance Mode.....	24
5.4.1	Enter Glance Mode	24
5.4.2	Screens	24
5.4.3	Exit Glance Mode	24
5.5	Menus.....	25
5.5.1	Operation Mode Navigation.....	25
6	Wireless Operation	26
6.1	Broadcast On Alarm And Remote Unit Sleep/Wakeup	26
6.1.1	Send Message.....	28
6.1.2	Broadcast Message.....	30
6.1.3	View Messages In AreaRAE Plus/Pro	31
6.1.4	Wake Unit Up/Put Unit To Sleep.....	32
6.1.5	Wake Unit Up (At Instrument).....	32
6.1.6	Wake Unit Up (From ProRAE Guardian).....	33
6.1.7	Put Unit To Sleep (From ProRAE Guardian)	34
7	Wireless Control And Submenus.....	35
7.1	ISM Settings.....	36
8	Wi-Fi Settings.....	37
8.1	Secure Wireless Access Point Configuration.....	37
8.2	Setting Wi-Fi Communication Parameters In ProRAE Studio II	38
8.2.1	Wi-Fi Power	39
8.2.2	Address.....	39
8.2.3	Channels And Security.....	39
8.2.4	Security Mode	39
8.2.5	Security Key.....	40
8.2.6	SSID	40
8.2.7	Server IP.....	40
8.2.8	Server Port.....	40
9	Relays For Controlling External Equipment.....	41
10	Battery.....	43
10.1	Charging.....	43
10.2	Battery States	44
10.3	External Battery Charger	44
10.3.1	External Battery Charger LED Indicators.....	45
11	Turning The AreaRAE Plus/Pro On And Off.....	46
11.1	Turning The AreaRAE Plus/Pro On	46
11.1.1	Pausing To View Screens During Startup.....	46
11.2	Turning The AreaRAE Plus/Pro Off.....	46
11.3	Testing Alarm Indicators	47
11.4	Pump Status	47
11.5	Calibration Status.....	47

AreaRAE Plus & AreaRAE Pro User's Guide

11.6	Bump Status	48
12	Programming	49
12.1	Enter Programming In Basic Mode	49
12.2	Enter Programming In Advanced Mode	50
12.3	Menus And Submenus	51
12.3.1	Editing And Selecting Parameters And Sensors	51
12.3.2	Calibration.....	52
12.3.2.1	Fresh Air.....	52
12.3.2.2	Multi Sensor Span	52
12.3.2.3	Single Sensor Zero.....	53
12.3.2.4	Single Sensor Span Calibration	54
12.3.2.5	Single Sensor Span 2 Calibration	55
12.3.2.6	Multi Sensor Bump.....	55
12.3.2.7	Single Sensor Bump	56
12.3.2.8	Cal. Reference	57
12.3.2.9	Change Cal. Gas	57
12.3.2.10	Multi Cal. Select.....	57
12.3.2.11	Change Span Value	58
12.3.2.12	Change Span 2 Value	58
12.3.3	LEL Calibration Procedure	59
12.3.3.1	Zero Sensor Calibration For The LEL Sensor	59
12.3.3.2	Span Calibration For The LEL Sensor	59
12.3.4	Measurement.....	60
12.3.4.1	Sensor On/Off.....	60
12.3.4.2	Change Meas. Gas	61
12.3.4.3	Measurement Unit	61
12.3.5	Alarms.....	63
12.3.5.1	Alarm Limits.....	63
12.3.5.2	Alarm Mode.....	63
12.3.5.3	Alarm Settings	63
12.3.5.4	Comfort Beep	63
12.3.6	Datalog.....	64
12.3.6.1	Clear Datalog	64
12.3.6.2	Datalog Interval	64
12.3.6.3	Sensor Selection	64
12.3.6.4	Data Selection.....	65
12.3.6.5	Datalog Type	65
12.3.6.6	Memory Full Action	66
12.3.7	Wireless	67
12.3.7.1	Select Primary Radio	67
12.3.7.2	GPS.....	67
12.3.7.3	Mesh	68
12.3.7.4	On/Off.....	68
12.3.7.5	PAN ID.....	68
12.3.7.6	Channel.....	69
12.3.7.7	Factory Reset.....	69
12.3.8	ISM	70
12.3.8.1	Power On/Off	70
12.3.8.2	Network ID	70
12.3.8.3	Unit ID.....	71
12.3.9	Wi-Fi.....	71
12.3.10	Message	73
12.3.11	Monitor	73
12.3.11.1	LCD Contrast.....	73

AreaRAE Plus & AreaRAE Pro User's Guide

12.3.11.2.	Zero At Start	74
12.3.11.3.	Fast Startup	74
12.3.11.4.	Language	74
12.3.11.5.	Site ID	74
12.3.11.6.	User ID	74
12.3.11.7.	Secure In Place	75
13	User Modes	78
13.1	Basic User Mode	78
13.2	Advanced User Mode	78
14	Policy Enforcement	78
14.1	Setting Policy Enforcement	78
14.2	Deactivating Policy Enforcement	80
15	Calibration And Testing	82
15.1	Manual Alarms Test	82
15.2	Bump Testing And Calibration	82
15.2.1	Bump (Functional) Testing	82
15.2.2	Bias & Equilibration For Liquid O ₂ And Other Biased Sensors	83
15.2.3	Testing The Gamma Radiation Sensor	84
15.2.4	Zero Calibration For Parts-Per-Billion (ppb) PID Sensor	84
15.2.5	Fresh Air Calibration	84
15.3	Span Calibration	85
15.4	Three-Point Calibration For Enhanced Linearity With Extended- Range And ppb PID Sensors	85
15.4.1	VOC Zero Calibration Procedure For Enhanced Linearity With Extended- Range And ppb PID Sensors	86
15.4.2	Enabling 3-Point Calibration Via ProRAE Studio II	87
15.4.3	Calibration Setup	87
15.4.3.1.	Using A T-Tube	87
15.4.3.2.	Calibrating Without A T-Tube	87
15.4.4	Multi-Sensor Span Calibration	88
15.4.5	Single-Sensor Span Calibration	89
16	Datalog Transfer, Monitor Configuration, and Firmware Upgrades Via Computer	90
16.1	Downloading Datalogs And Performing PC-Based Instrument Configuration And Firmware Upgrades	90
17	Maintenance	91
17.1	Removing/Installing The Rubber Boot	91
17.2	Replacing The External Filter	91
17.3	Removing/Cleaning/Replacing Sensor Modules	92
17.3.1	Handling, Storage, And Calibration Of HF and HCL Sensors	93
17.3.2	Sensor Locations	94
17.4	Cleaning Or Replacing The PID	94
17.4.1	Cleaning Or Replacing The 4R+ PID	95
17.4.2	Cleaning Or Replacing The 7R+ PID	97
17.4.2.1.	Cleaning The PID Electrode Panel	100
17.4.2.2.	Cleaning The Lamp Housing Or Changing The Lamp	100
17.5	Replacing The Sensor Compartment Cover	102
17.6	Battery Removal/Replacement	102
17.7	RAEMet Meteorological Sensor (Optional)	104
17.8	Antenna Installation	105
17.9	VOC Carbon Filter For CO Sensor	106
17.10	Exhaust Gas Collector For Diverting Output Or Collecting Gas Samples	106
17.11	Base Plate For Tripod Mounting (Optional)	107
17.12	Replacing The Pump	108
18	Alarms Overview	110

AreaRAE Plus & AreaRAE Pro User's Guide

18.1	Alarm Signals.....	110
18.2	Changing The Alarm Mode	110
19	Diagnostic Mode.....	111
19.1	Enter Diagnostic Mode	111
19.2	Adjusting Alarm LEDs & Buzzer	111
19.3	Adjusting LCD Contrast	111
19.4	Pump Stall Threshold Adjustment	111
19.4.1	Entering Diagnostic Mode To Set The Pump Stall Threshold.....	112
19.4.2	Selecting The Pump Stall Threshold Method	112
19.4.3	Setting Pump Stall Threshold Values – Dynamic Method	113
19.4.4	Setting Pump Stall Threshold Values – Static Method.....	115
19.4.4.1	Stall High Threshold Setting – Static Method.....	115
19.4.4.2	Verifying the Stall High Setting	116
19.4.4.3	Stall Low Threshold Setting - Static.....	116
19.4.4.4	Verifying the Stall Low Setting - Static	116
19.5	Exit Diagnostic Mode	116
19.6	Alarm Signal Summary.....	117
19.6.1	Hygiene Mode.....	117
19.6.2	General Alarms	118
20	Troubleshooting.....	119
21	Specifications.....	120
21.1	AreaRAE Plus/Pro Wireless Configurations	121
21.2	Sensor Specifications	122
22	Technical Support.....	125
23	RAE Systems by Honeywell Contacts.....	126

AreaRAE Plus & AreaRAE Pro User's Guide



Read Before Operating

This manual must be carefully read by all individuals who have or will have the responsibility of using, maintaining, or servicing this product. The product will perform as designed only if it is used, maintained, and serviced in accordance with the manufacturer's instructions.

CAUTION!

Never operate the monitor when the cover is removed. Remove the monitor rear cover (gas plate cover) or battery only in an area known to be non-hazardous.

ANY RAPID UP-SCALE READING FOLLOWED BY A DECLINING OR ERRATIC READING MAY INDICATE A GAS CONCENTRATION BEYOND UPPER SCALE LIMIT, WHICH MAY BE HAZARDOUS.

TOUTE LECTURE RAPIDE ET POSITIVE, SUIVIE D'UNE BAISSSE SUBITE OU ERRATIQUE DE LA VALEUR, PEUT INDIQUER UNE CONCENTRATION DE GAZ HORS GAMME DE DÉTECTION QUI PEUT ÊTRE DANGEREUSE

ONLY THE COMBUSTIBLE GAS DETECTION PORTION OF THIS INSTRUMENT HAS BEEN ASSESSED FOR PERFORMANCE.

UNIQUEMENT, LA PORTION POUR DÉTECTER LES GAZ COMBUSTIBLES DE CET INSTRUMENT A ÉTÉ ÉVALUÉE.

CAUTION: BEFORE EACH DAY'S USAGE, SENSITIVITY OF THE LEL SENSOR MUST BE TESTED ON A KNOWN CONCENTRATION OF METHANE GAS EQUIVALENT TO 20 TO 50% OF FULL-SCALE CONCENTRATION. ACCURACY MUST BE WITHIN 0 AND +20% OF ACTUAL. ACCURACY MAY BE CORRECTED BY CALIBRATION PROCEDURE.

ATTENTION: AVANT CHAQUE UTILISATION JOURNALIERE, VERIFIER LA SENSIBILITE DU CAPTEUR DE LIE AVEC UNE CONCENTRATION CONNUE DE METHANE EQUIVALENTE DE 20 A 50% DE LA PLEINE ECHELLE. LA PRECISION DOIT ETRE COMPRISE ENTRE 0 ET 20% DE LA VALEUR VRAIE ET PEUT ETRE CORRIGEE PAR UNE PROCEDURE D'ETALONNAGE.

CAUTION: HIGH OFF-SCALE READINGS MAY INDICATE AN EXPLOSIVE CONCENTRATION.

ATTENTION: DES LECTURES HAUTES ET HORS D'ECHELLE PEUVENT INDIQUER DES CONCENTRATIONS DE GAZ INFLAMMABLES

CAUTION: SUBSTITUTION OF COMPONENTS MAY IMPAIR INTRINSIC SAFETY.

Note: Users are recommended to refer to ISA-RP12.13, Part II-1987 for general information on installation, operation, and maintenance of combustible gas detection instruments.

The AreaRAE Plus/Pro multi-gas detector must be calibrated if it does not pass a bump test, or at least once every 180 days, depending on use and sensor exposure to poisons and contaminants.

AreaRAE Plus & AreaRAE Pro User's Guide

CAUTION!

The AreaRAE, PGM-65XXX shall only be charged using a charger specifically supplied for use with the unit with a maximum output voltage of 12V, 7.5A, 60950-certified.

Use of non-RAE Systems components will void the warranty and can compromise the safe performance of this product.

MARKING

The PGM-65XXX is marked with the following information:

RAE SYSTEMS

3775 N. 1st. St., San Jose

CA 95134, USA

Type PGM-65XXX.

Serial No/barcode: XXXX-XXXX-XX

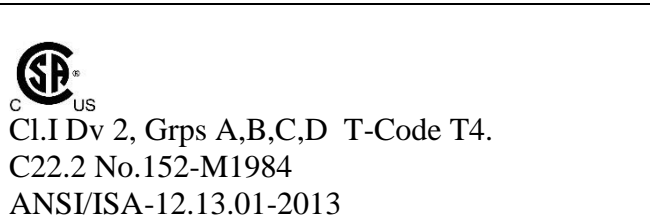

-20° C < Tamb < +50° C;

CAUTION: READ AND UNDERSTAND INSTRUCTION MANUAL BEFORE OPERATING OR SERVICING
ATTENTION: LIRE ET COMPRENDRE MANUEL D'INSTRUCTIONS AVANT D'UTILISER OU SERVICE.

FCC Part 15 Statement

This device complies with Part 15 of the FCC rules. Operation is subject to the following two conditions:
(1) This device may not cause harmful interference, and (2) this device must accept any interference received, including interference that may cause undesired operation.

Caution:

This device complies with Part 15 of the FCC Rules / Industry Canada license-exempt RSS standard(s). Operation is subject to the following two conditions: (1) this device may not cause harmful interference, and (2) this device must accept any interference received, including interference that may cause undesired operation.

Le présent appareil est conforme aux CNR d'Industrie Canada applicables aux appareils radio exempts de licence. L'exploitation est autorisée aux deux conditions suivantes : (1) l'appareil ne doit pas produire de brouillage, et (2) l'utilisateur de l'appareil doit accepter tout brouillage radioélectrique subi, même si le brouillage est susceptible d'en compromettre le fonctionnement.

Changes or modifications not expressly approved by the party responsible for compliance could void the user's authority to operate the equipment.

This equipment has been tested and found to comply with the limits for a Class B digital device, pursuant to part 15 of the FCC Rules. These limits are designed to provide reasonable protection against harmful interference in a residential installation. This equipment generates uses and can radiate radio frequency

AreaRAE Plus & AreaRAE Pro User's Guide

energy and, if not installed and used in accordance with the instructions, may cause harmful interference to radio communications. However, there is no guarantee that interference will not occur in a particular installation. If this equipment does cause harmful interference to radio or television reception, which can be determined by turning the equipment off and on, the user is encouraged to try to correct the interference by one or more of the following measures:

- Reorient or relocate the receiving antenna.
- Increase the separation between the equipment and receiver.
- Connect the equipment into an outlet on a circuit different from that to which the receiver is connected.
- Consult the dealer or an experienced radio/TV technician for help.

Under Industry Canada regulations, this radio transmitter may only operate using an antenna of a type and maximum (or lesser) gain approved for the transmitter by Industry Canada. To reduce potential radio interference to other users, the antenna type and its gain should be so chosen that the equivalent isotropically radiated power (e.i.r.p.) is not more than that necessary for successful communication.

Conformément à la réglementation d'Industrie Canada, le présent émetteur radio peut fonctionner avec une antenne d'un type et d'un gain maximal (ou inférieur) approuvé pour l'émetteur par Industrie Canada. Dans le but de réduire les risques de brouillage radioélectrique à l'intention des autres utilisateurs, il faut choisir le type d'antenne et son gain de sorte que la puissance isotrope rayonnée équivalente (p.i.r.e.) ne dépasse pas l'intensité nécessaire à l'établissement d'une communication satisfaisante.

This device complies with Industry Canada's licence-exempt RSSs. Operation is subject to the following two conditions:

- (1) This device may not cause interference; and
- (2) This device must accept any interference, including interference that may cause undesired operation of the device.

AreaRAE Plus & AreaRAE Pro User's Guide

MPE Reminder

To satisfy FCC / IC RF exposure requirements, a separation distance of 20 cm or more should be maintained between the antenna of this device and persons during device operation.

To ensure compliance, operation at closer than this distance is not recommended.

Les antennes installées doivent être situées de façon à ce que la population ne puisse y être exposée à une distance de moins de 20 cm. Installer les antennes de façon à ce que le personnel ne puisse approcher à 20 cm ou moins de la position centrale de l'antenne.

La FCC des états-unis stipule que cet appareil doit être en tout temps éloigné d'au moins 20 cm des personnes pendant son fonctionnement.

Only for detachable antennas:

This radio transmitter (identify the device by certification number, or model number if Category II) has been approved by Industry Canada to operate with the antenna types listed below with the maximum permissible gain and required antenna impedance for each antenna type indicated. Antenna types not included in this list, having a gain greater than the maximum gain indicated for that type, are strictly prohibited for use with this device.

MESH	Freewave 900	Wi-Fi	Freewave 2400
Gain of antenna: 3.0dBi	Gain of antenna: 2.0dBi	Gain of antenna: 4.9dBi	Gain of antenna: 2.5dBi Max
Type of antenna: Omnidirectional	Type of antenna: Omnidirectional	Type of antenna: Omnidirectional	Type of antenna: Omnidirectional
Impedance of antenna: 50 ohms	Impedance of antenna: 50 ohms	Impedance of antenna: 50 ohms	Impedance of antenna: 50 ohms

Le présent émetteur radio (identifier le dispositif par son numéro de certification ou son numéro de modèle s'il fait partie du matériel de catégorie II) a été approuvé par Industrie Canada pour fonctionner avec les types d'antenne énumérés ci-dessous et ayant un gain admissible maximal et l'impédance requise pour chaque type d'antenne. Les types d'antenne non inclus dans cette liste, ou dont le gain est supérieur au gain maximal indiqué, sont strictement interdits pour l'exploitation de l'émetteur.

MESH	Freewave 900	Wi-Fi	Freewave 2400
Gain d'antenne: 3.0dBi	Gain d'antenne: 2.0dBi	Gain d'antenne: 4.9dBi	Gain d'antenne: 2.5dBi Max
Type d'antenne: Omni-directional	Type d'antenne: Omni-directional	Type d'antenne: Omni-directional	Type d'antenne: Omni-directional
Impedance d'antenne: 50ohm	impédance d'antenne: 50ohm	impédance d'antenne: 50ohm	impédance d'antenne: 50ohm

AreaRAE Plus & AreaRAE Pro User's Guide

Wireless Security Warning

Wireless data transmission can extend beyond your walls and can be received by anyone with a compatible adapter. Without proper protection, data can be compromised. Use the security features of all wireless equipment in your network.

Each AreaRAE Plus/Pro has a default name and password. You should change these to personalize them upon first installation, which lessens the potential security risk that an unauthorized user can change the configuration.

After all configuration activities are completed, verify the each AreaRAE Plus/Pro for function with the location software separately from the system in which it will be operating.

IMPORTANT!

Other Wi-Fi devices may transmit specific Wi-Fi messages that interfere with AreaRAE Plus/Pro and other wireless devices in a wirelessly networked system. You should not allow any untrusted Wi-Fi transmitters inside the area of location and in its proximity (approximately 50 meters).

Operation Area and Conditions

Hazardous Areas classified by Divisions

PGM-65XXX is intended to be used in hazardous areas classified for Class I Div. 2, within the temperature range of -20° C to +50° C, where gases of explosion groups A, B, C or D and temperature code T4 may be present.

INSTRUCTIONS FOR SAFE USE

WARNING: Read and understand instruction manual before operation or servicing.

AVERTISSEMENT: Lisez et comprenez le manual d'instructions avant d'utiliser ou d'effectuer l'entretien.

WARNING: Substitution of components may impact safety.

AVERTISSEMENT: La substitution de composants peut compromettre la sécurité.

WARNING: To prevent ignition of a hazardous atmosphere, batteries must only be charged in an area known to be non-hazardous area in the ambient temperature range $0^{\circ} \text{C} \leq T_{\text{amb}} \leq 40^{\circ} \text{C}$. Use only approved charger.

AVERTISSEMENT: Afin de prévenir l'inflammation d'atmosphères dangereuse, ne charger le jeu de batteries que dans des emplacement designés non dangereux a temperature ambiante $0^{\circ}\text{C} \leq T_{\text{amb}} \leq 40^{\circ}\text{C}$ Utilisez uniquement un chargeur approuvé.

WARNING: As a condition of certification, connection may not be made to the communication port when the Gas Detector is in the hazardous location unless the area is known not to be hazardous.

AVERTISSEMENT: Comme condition de la certification, un connexion filaire ne peut pas être faite via le port de communication lorsque le détecteur de gaz est dans la zone dangereuse à moins que la zone soit connue pour ne pas être dangereuse.

WARNING: Li-Ion rechargeable battery: Only use approved battery pack: W01-3007-000 or W01-3007-100.

AVERTISSEMENT: Batterie rechargeable Li-Ion: Utilisez uniquement des batteries approuvé: W01-3007-000 ou W01-3007-100.

AreaRAE Plus & AreaRAE Pro User's Guide

USE IN HAZARDOUS AREAS

Equipment which is intended for use in explosive atmospheres and which has been assessed and certified according to international regulations may be used only under specified conditions. The components may not be modified in any way.

- (i) Connection must only be made to the Vdc input jack and to the USB communication port when the instrument is in non-hazardous location or unless the area is known to be non-hazardous.
- (ii) The battery pack shall only be charged or replaced in a non-hazardous location.
- (iii) The sensors shall only be replaced in a non-hazardous location.
- (iv) The external connection to the PGM 65xxx shall be in accordance to control drawing W01 0901-CTL. The external alarms that are to be connected to PGM 65xxx must be suitable for the hazardous location where they are mounted, and supplied from Class 2 power supply or equivalent. The wiring method shall be to local electrical code and installation are subject to acceptance by authority having jurisdiction.

The appropriate regulations for service and repair must be properly observed during such activities.

PGM-65XXX contains a connector for mounting of a wind sensor – RAEMet. This connector has a set of entity parameters that match the input entity parameters of RAEMet:

Uo: 5.2V; Po: 0.788W; Lo: 198 μ H; Co: 1000 μ F.

Keep all ports covered when they are not in use. This keeps moisture and debris out of the ports and contributes to the instrument's safety.

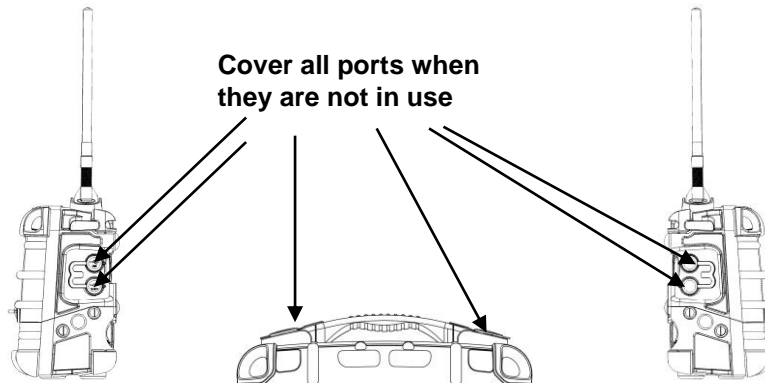

Proper Product Disposal At End Of Life



The Waste Electrical and Electronic Equipment (WEEE) directive (2002/96/EC) is intended to promote recycling of electrical and electronic equipment and their components at end of life. This symbol (crossed-out wheeled bin) indicates separate collection of waste electrical and electronic equipment in the EU countries. This product may contain one or more Nickel-metal hydride (NiMH), Lithium-ion, or Alkaline batteries. Specific battery information is given in this user guide. Batteries must be recycled or disposed of properly.

At the end of its life, this product must undergo separate collection and recycling from general or household waste. Please use the return and collection system available in your country for the disposal of this product.

AreaRAE Plus & AreaRAE Pro User's Guide

Sensor Specifications, Cross-Sensitivities, And Calibration Information

For information on sensor specifications, cross-sensitivities, and calibration information, refer to RAE Systems Technical Note TN-114: Sensor Specifications And Cross-Sensitivities (available for free download from www.raesystems.com/downloads/tech-notes). All specifications presented in this Technical Note reflect the performance of stand-alone sensors. Actual sensor characteristics may vary when the sensor is installed in different instruments. As sensor performance may change over time, specifications provided are for brand-new sensors.

AreaRAE Plus & AreaRAE Pro User's Guide

1 Features Comparison

The AreaRAE Plus and AreaRAE Plus/Pro share many of the same features and the same housing. This user's guide details all features, including those that are only available on the AreaRAE Plus/Pro (depending your instrument's configuration it may be configured with a different number of sensors, different primary radio type, etc.).

The table below shows the features on the AreaRAE Plus and AreaRAE Plus/Pro.

		AreaRAE Plus (PGM-6520)	AreaRAE Pro (PGM-6560)
Gas Sensors			
Number of Gas Sensor Slots		7	7
VOC		7R+ 10.6eV Lamp PID (0.1ppm) 4R+ 10.6eV Lamp PID (0.1 ppm) 4R+ 9.8eV Lamp PID (1 ppm)	7R+ 10.6eV Lamp PID (10 ppb) 4R+ 10.6eV Lamp PID (10 ppb) 4R+ 9.8eV Lamp PID (1 ppm)
Combustible		LEL	LEL
NDIR CO₂ Sensor		CO ₂	CO ₂
Toxic EC		Up to 6	Up to 6
Supported Sensors		O ₂ , CO, CO ext., CO & H ₂ , H ₂ S, H ₂ S ext., SO ₂ , NO, NO ₂ , HCN, NH ₃ , PH ₃ , HCl, HF, ETO-A, ETO-B, ETO-C, Cl ₂ , ClO ₂ , H ₂	O ₂ , CO, CO ext., CO & H ₂ , H ₂ S, H ₂ S ext., SO ₂ , NO, NO ₂ , HCN, NH ₃ , PH ₃ , HCl, HF, ETO-A, ETO-B, ETO-C, Cl ₂ , ClO ₂ , H ₂
Other Sensors			
Gamma		No	Yes (optional)
RAEMet (Wind Speed, Direction, Temperature, Relative Humidity)		Yes (optional)	Yes
GPS		Yes	Yes
Wireless			
Long Range	ISM Band	900/2400 MHz	900/2400 MHz
	Wi-Fi	Optional	Optional
Short Range	Mesh	915/868 MHz	915/868 MHz
RF Antenna		Vertical Polarization, Spring Base	Vertical Polarization, Spring Base
Solid-State Relays		Yes (3)	Yes (3)

AreaRAE Plus & AreaRAE Pro User's Guide

2 Standard Contents

The AreaRAE Pro and AreaRAE Plus kit includes:

- AreaRAE Pro or AreaRAE Plus monitor with sensors, battery, and wireless options as specified and protective rubber boot installed
- USB communication cable
- AC/DC power adapter (90-264VAC input) plus power cords
- Spare rechargeable battery
- 3 Spare external filters
- Phillips screwdriver
- Flathead screwdriver
- 4R+ PID opening tool (if instrument is equipped with a PID sensor)
- 7R+ PID cover opening tool (if instrument is equipped with a PID sensor)
- PID lamp removal tool (if instrument is equipped with a PID sensor)
- Lamp-cleaning kit (isopropanol)
- “T”-type calibration tube
- QuickStart Guide
- CD with documentation
- CD with ProRAE Studio II instrument configuration and data management software
- Calibration and test certificate

Optional accessories:

Exhaust Gas Collector (P/N: W01-3020-000)

Tripod Base Plate (P/N: W01-3018-000)

VOC filter for CO sensors, package of 5 (P/N: W01-3019-000)

3 General Information

Honeywell's AreaRAE Plus/Pro is a wireless, transportable area monitor that can simultaneously detect toxic and combustible gases, carbon dioxide, volatile organic chemicals (VOCs), radiation and meteorological factors. Whether being used into a HazMat response, deploying it at a public venue or installed as part of a fence-line detection system — for hours, days or weeks at a time — the AreaRAE Plus/Pro gives you the right hazard intelligence so you can ensure safety for your teams and the general public.

The AreaRAE Plus/Pro also facilitates Industrial Fence-line monitoring and has the capability to trigger additional devices via relays.

Remote real-time monitoring of sensor data and alarm status is achieved via ProRAE Guardian software.

AreaRAE Plus & AreaRAE Pro User's Guide

3.1 Key Features

- Up to seven gas sensors (PID, LEL, CO₂, Toxics)
- Dedicated radiation sensor slot – Gamma sensor
- RAEMet station for wind speed and direction, ambient temperature, and relative humidity
- Multiple onboard wireless options:
 - Primary radio: ISM (900/2400 MHz)/Wi-Fi
 - Secondary radio: Mesh
- CID2 certified for U.S. and Canada
- Standard GPS module
- Relay outputs
- On the field interchangeable gas sensor (4R+ Smart sensor)
- Colored rubber boots
- Spare rechargeable battery
- External battery charger
- 108dB alarm buzzer
- Wraparound LED alarm
- Easy serviceability (access to pump/gas sensors/battery)
- Large Screen and intuitive User interface using icon and text (translated)
- User interface available in 9 languages: Brazilian Portuguese, Chinese, Dutch, English, French, German, Italian, Russian, Spanish

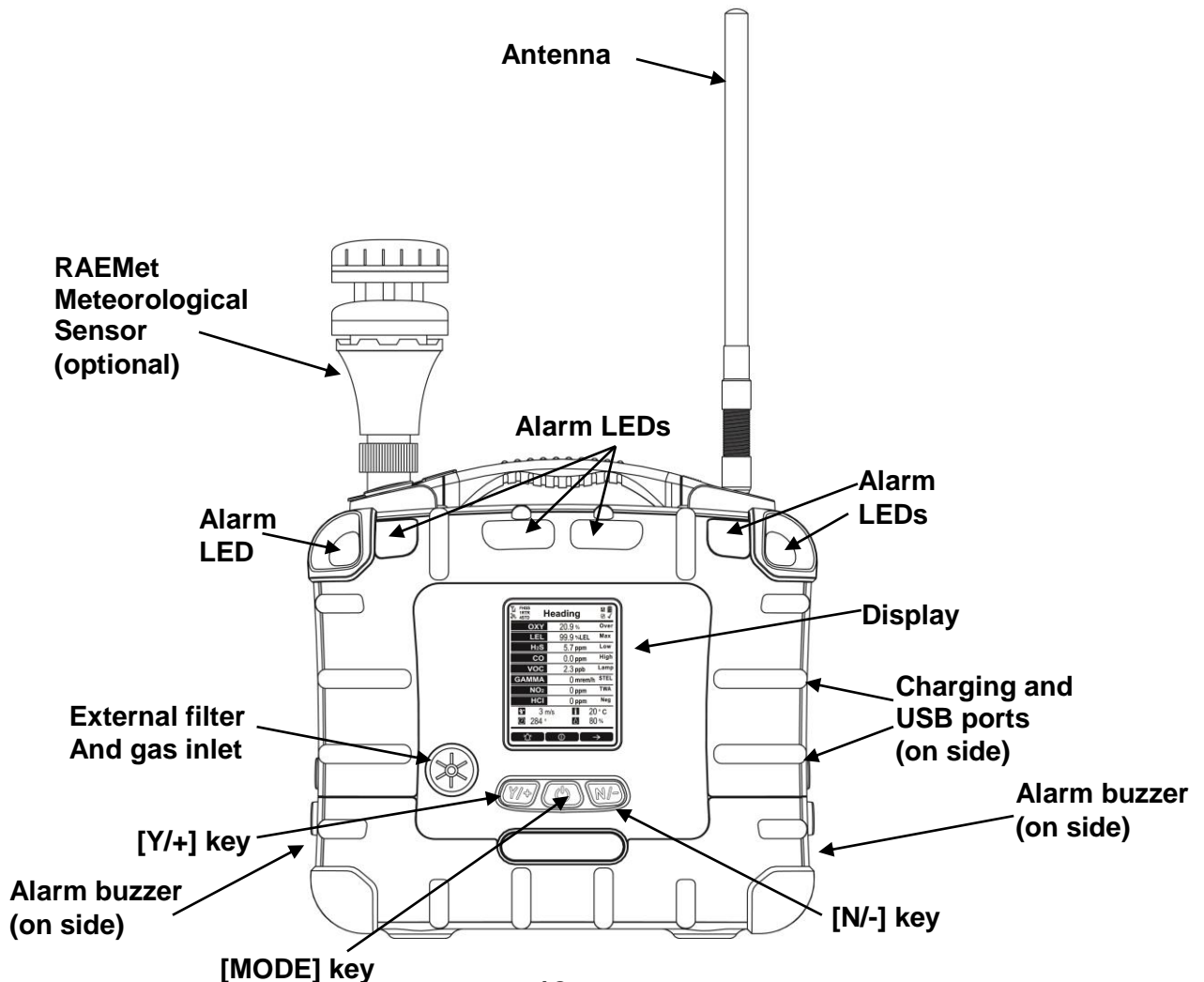

AreaRAE Plus & AreaRAE Pro User's Guide

4 Connections

The AreaRAE Plus/Pro has six physical ports located on the left, right, and top sides. The rubber boot has integral caps for covering the ports when they are not in use.

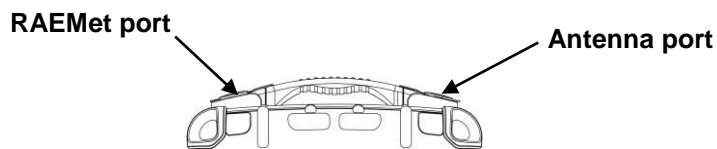
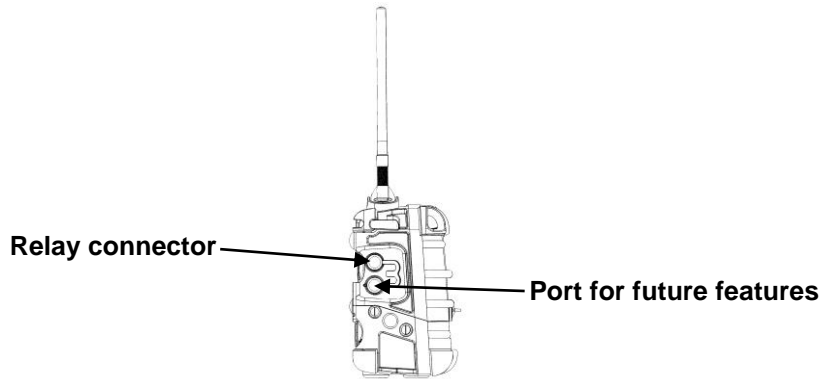
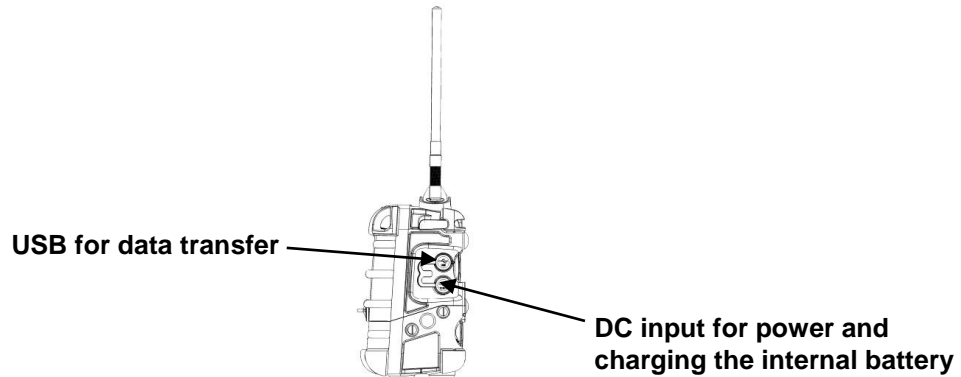

IMPORTANT!

Keep all ports covered when they are not in use. This keeps moisture and debris out of the ports and contributes to the instrument's intrinsic safety.

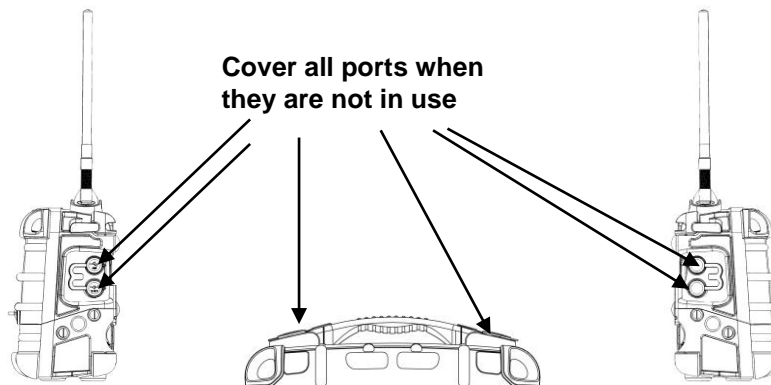

AreaRAE Plus & AreaRAE Pro User's Guide

5 User Interface

The AreaRAE Plus/Pro's user interface consists of the display, alarm LEDs, an alarm buzzer, and three keys.

5.1 Display Overview

The LCD display provides visual feedback that includes the sensor types, readings, alarm status, battery condition, and other information.

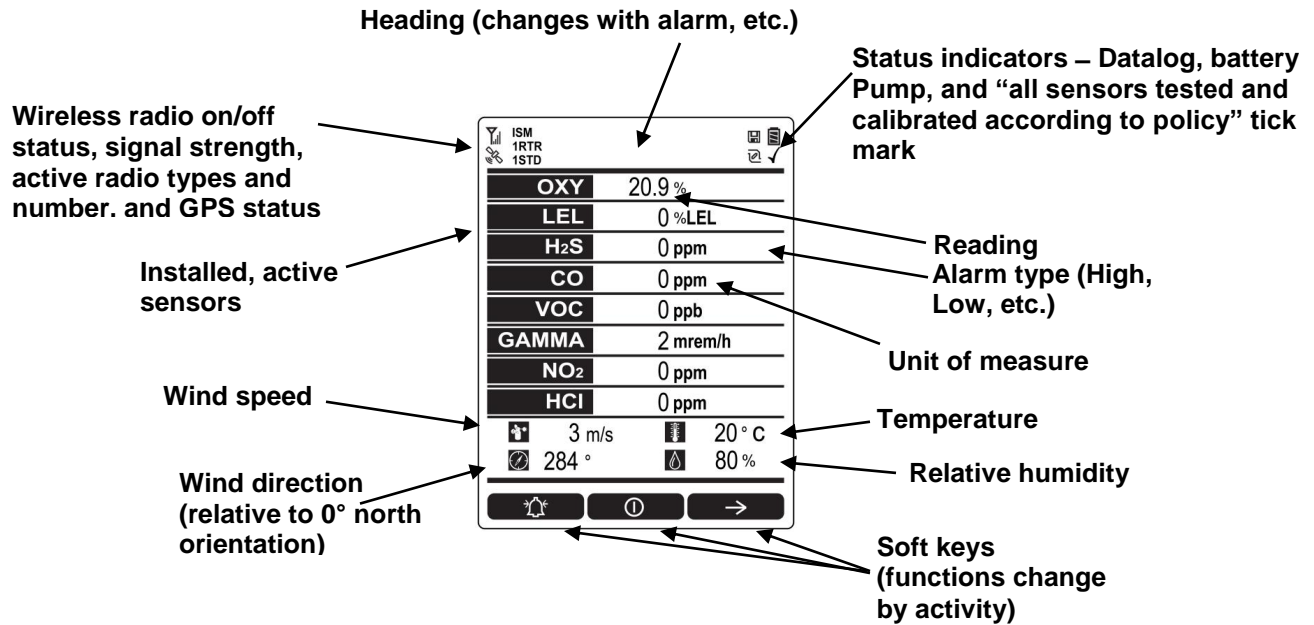





















5.1.1 Status Indicator Icons

Along the top of most screens are status indicators that tell you whether a function is operating and/or its strength or level.

Icon	Function
	Wireless status: the ISM or Wi-Fi radio is on (blinks when it cannot find a network)
	Wireless status: the ISM or Wi-Fi radio is off
	ISM or Wi-Fi radio signal 0% to 19%
	ISM or Wi-Fi radio signal 20% to 39%
	ISM or Wi-Fi radio signal 40% to 79%
	ISM or Wi-Fi radio signal 80% to 100%
ISM or Wi-Fi	Long-haul radio type (ISM or Wi-Fi)
RTR	Number of Mesh Routers connected
STD	Number of standard mesh-radio devices connected







AreaRAE Plus & AreaRAE Pro User's Guide

	GPS enabled and power is off
	(flashing) Cannot find satellite
	1 to 3 satellites
	4 to 8 satellites
	9 to 12 satellites
	Pump operating normally (alternates between these two icons)
	Pump blocked (blinks once per second)
	Datalogging status (shown when datalogging is on, blank when off)
	Battery voltage is $\geq 80\%$
	Battery voltage is $\geq 50\%$ and $< 80\%$
	Battery voltage is $\geq 10\%$ and $< 50\%$
	Battery voltage is $< 10\%$
	Battery error
	Sensor due for calibration
	Sensor due for a bump test
	“All electrochemical sensors tested and calibrated to policy” tick mark (all sensors have been bump tested and calibrated; no sensor is overdue for a bump test or calibration according to the intervals configured on the instrument). This icon is not shown if any sensor is due for bump testing or calibration, or if policy enforcement is turned off
	Wind speed
	Wind direction
	Temperature
	Relative humidity

AreaRAE Plus & AreaRAE Pro User's Guide

5.1.2 Status Indicator Icons For Instruments Equipped with ISM Radio or Wi-Fi

AreaRAE Plus/Pro instruments equipped with optional ISM radio or Wi-Fi use specific icons to indicate functionality.

Icon	Description
	ISM or Wi-Fi power is off
	Cannot find network
	Received signal strength is >0 and <20%
	Received signal strength is ≥20% and <40%
	Received signal strength is ≥40% and <60%
	Received signal strength is ≥60% and <80%
	Received signal strength is ≥80%

AreaRAE Plus & AreaRAE Pro User's Guide

5.2 Keys And Interface

The AreaRAE Plus/Pro has three keys:



In addition to their labeled functions, [Y/+], [MODE], and [N/-] act as “soft keys” that control different parameters and make different selections within the instrument’s menus. From menu to menu, each key controls a different parameter or makes a different selection.

Three panes along the bottom of the display are “mapped” to the keys. These change as menus change, but at all times the left pane corresponds to the [Y/+] key, the center pane corresponds to the [MODE] key, and the right pane corresponds to the [N/-] key. Here are examples that show the relationships of the keys and functions:

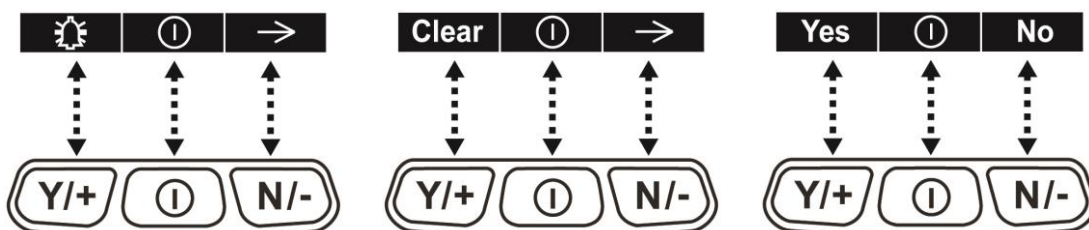

In addition to the functions described above, any of the keys can be used to manually activate display backlighting. Press any key when the backlighting is off to turn it on. A subsequent key press is required to carry out an actual function corresponding to that key.

5.2.1 Reverse Direction

Sometimes you want to go back to a previous screen rather than advance through an entire set of screens before “wrapping around” to that screen again.

To reverse direction:

1. Press and hold [N/-] for 3 seconds.
2. When the arrow changes from pointing to the right to pointing to the left, release your finger.

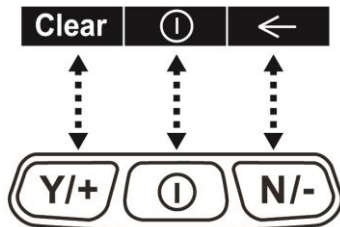

Now when you press [N/-], you step back through the screens.

To change direction again: Press and hold [N/-] for 3 seconds and then release.

Note: Changing direction does not work with all screens. It works primarily in submenus.

AreaRAE Plus & AreaRAE Pro User's Guide

5.3 Screen Display For Various Numbers Of Active Sensors

The AreaRAE Plus/Pro can display readings from one to eight sensors, plus four meteorology sensors (wind speed, wind direction, temperature, relative humidity) depending on the AreaRAE Plus/Pro's configuration. In order to maximize readability and the amount of information shown, the display is automatically reconfigured, according to the number and types of sensors in the AreaRAE Plus/Pro.

The screenshot shows a handheld device screen with a status bar at the top containing 'ISM', '1RTR', and '1STD' along with signal strength and battery icons. The main display area is a list of sensor readings:

OXY	20.9 %
LEL	0 %LEL
H ₂ S	0 ppm
CO	0 ppm
VOC	0 ppb
GAMMA	2 mrem/h
NO ₂	0 ppm
HCl	0 ppm
3 m/s	20 ° C
284 °	80 %

At the bottom, there are three navigation buttons: a bell icon, a power icon, and a right arrow icon.

8 Sensors with meteorology sensors

The screenshot shows a handheld device screen with a status bar at the top containing 'ISM', '1RTR', and '1STD' along with signal strength and battery icons. The main display area is a list of sensor readings:

OXY	20.9 %
LEL	0 %LEL
H ₂ S	0 ppm
CO	0 ppm
VOC	0 ppb
GAMMA	2 mrem/h
NO ₂	0 ppm
HCl	0 ppm

At the bottom, there are three navigation buttons: a bell icon, a power icon, and a right arrow icon.

8 sensors without meteorology sensors

5.4 Glance Mode

Glance Mode allows you to get vital information without turning on the AreaRAE Plus/Pro. You can check information such as the instrument's model and serial number, installed sensor types, wireless modules installed, etc., which may help when taking inventory of instruments and their sensors or when working with service or support personnel. Glance Mode can be enabled/disabled via ProRAE Studio II.

5.4.1 Enter Glance Mode

Note: The instrument must be configured so that Glance Mode is turned on (the default mode is "Off"). This can be done in ProRAE Studio II.

With the AreaRAE Plus/Pro turned off, press and hold [Y/+] to enter Glance Mode. The feature is latched, meaning that it runs even after you release the [Y/+] key. If you see the message "GLANCE DISABLED," you must configure the instrument to use Glance Mode.

If Glance Mode is enabled, the first screen is displayed. After releasing [Y/+], other screens can be displayed by pressing the [N/-] Key. In ProRAE Studio II, Glance Mode can be enabled or disabled by checking or unchecking the box labeled "Enable Glance Mode."

5.4.2 Screens

Every screen displayed in sequence as configuration. Press [N/-] to advance to the next screen.

Press [MODE] to exit Glance Mode. The screens are shown in sequence.

5.4.3 Exit Glance Mode

The AreaRAE Plus/Pro exits Glance Mode and turns off when you press the [MODE] key. In addition, if you do not press either key in 60 seconds, the AreaRAE Plus/Pro automatically exits Glance Mode.

AreaRAE Plus & AreaRAE Pro User's Guide

5.5 Menus

The reading menus are easy to step through by pressing the [N/-] key.

Notes:

- If the instrument is not equipped with a VOC sensor (PID), or is not equipped with an LEL sensor, then screens for those sensors (VOC Gas Status and LEL Gas Status, respectively) are not shown.
- If ISM or Wi-Fi is not the primary modem, its menu is not displayed.

5.5.1 Operation Mode Navigation

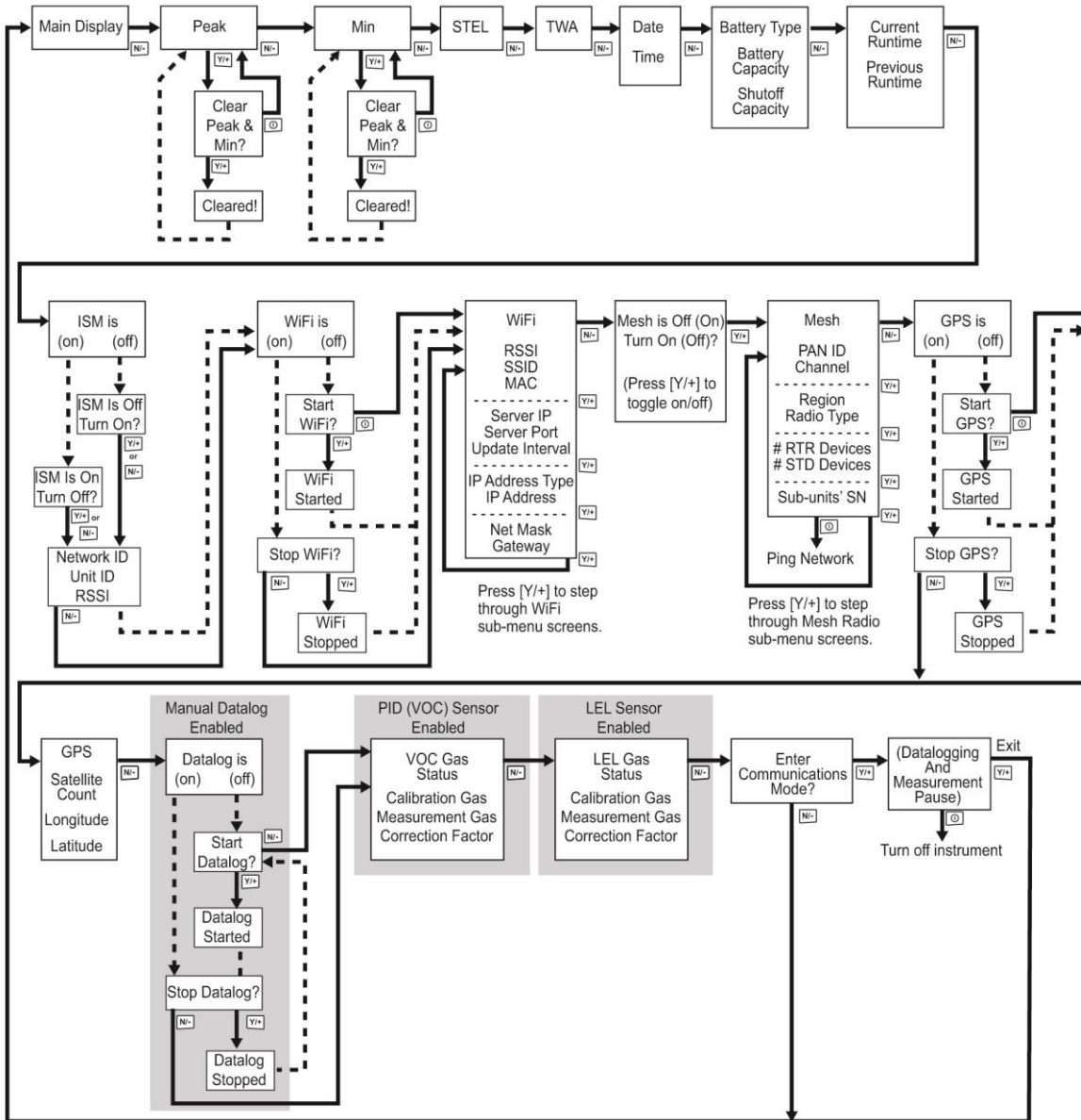

Note: Dashed line indicates automatic progression.

6 Wireless Operation

Depending on the wireless configuration of the instrument and which radio modules are active, the AreaRAE Plus/Pro can communicate directly through ISM-band radio to a RAELink3 wireless Host modem or via Wi-Fi to a Wi-Fi access point. In addition, the AreaRAE Plus/Pro is equipped with a Mesh-radio modem that communicates with Mesh-equipped instruments such as the MultiRAE, ToxiRAE Pro, etc., located up to 330 feet (100 meters) away. Up to eight of these instruments' data can be relayed through the AreaRAE Plus/Pro to a PC running ProRAE Guardian to monitor them, as well as the AreaRAE Plus/Pro.

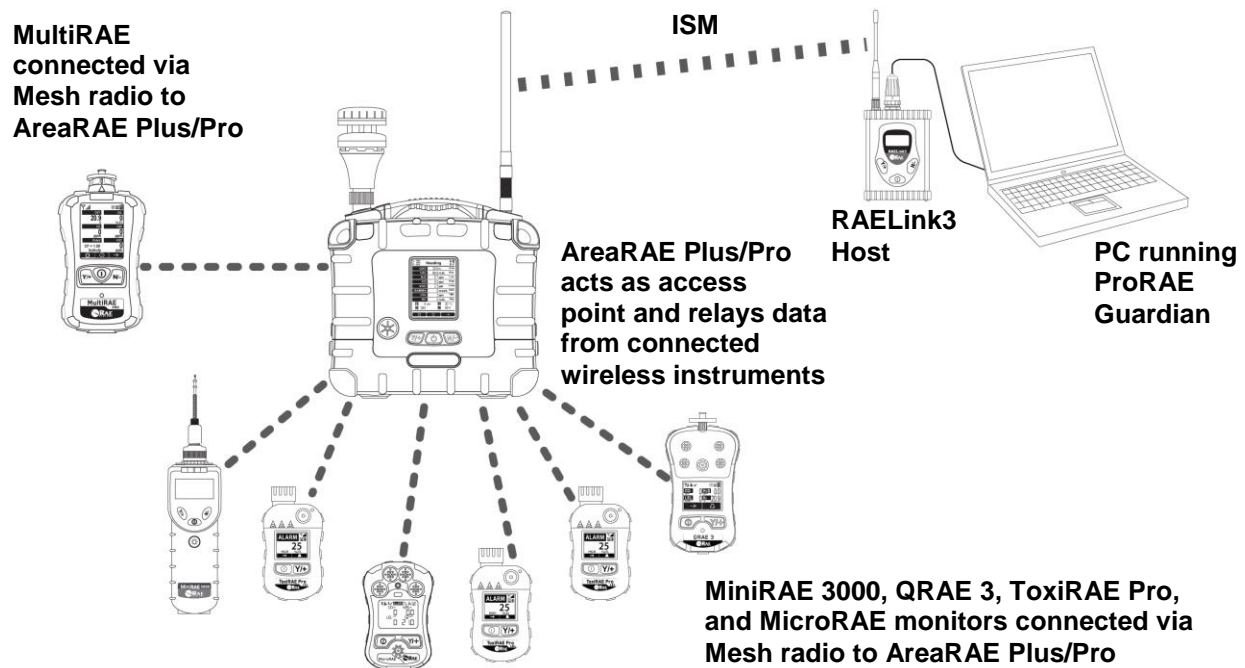

Note: If the AreaRAE Pro or AreaRAE Plus is equipped with Wi-Fi, and Wi-Fi is used as the primary radio instead of ISM, then a Wi-Fi access point substitutes for the RAELink3 Host.

Note: The ISM radio acts as a repeater, providing extended range for other instruments operating with it.

Note: AreaRAE Plus/Pro can receive up to 10 different messages from a base station PC running ProRAE Guardian. The AreaRAE Plus/Pro can only receive a message from ProRAE Guardian when it is in Normal mode, and when there are no active alarms.

6.1 Broadcast On Alarm And Remote Unit Sleep/Wakeup

Using ProRAE Guardian, you can control remote functions in the AreaRAE Plus/Pro.

1. Turn on your AreaRAE Plus/Pro.
2. Start ProRAE Guardian for your system.
3. Click “Data Sources.”



4. When the “Data Sources” window appears, check that the correct Serial Port is active.

AreaRAE Plus & AreaRAE Pro User's Guide

5. Program the “Broadcast On Alarm” settings. Select “Broadcast on Alarm” to send a message to the entire system (via ISM or Wi-Fi) when an instrument goes into alarm. You can set the Alarm Interval to the time after each alert to be repeated (this is set in seconds; 2 seconds is the default value).

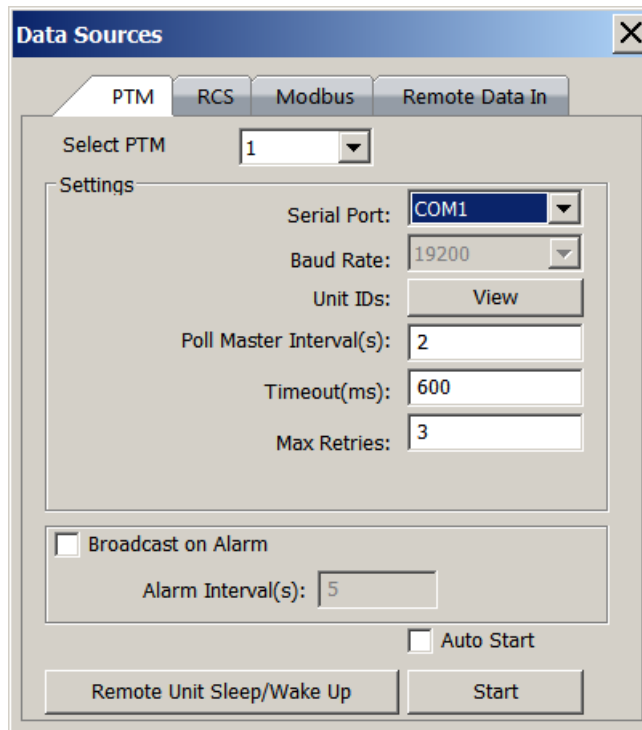

Click the “Remote Unit Sleep/Wakeup” button to access the screen with four buttons/functions:

Button	Function
Send Message	Sends a message to a selected unit
Broadcast Message	Sends a message to all units on the same network
Wake Unit Up	Wakes up a selected unit that is currently in Sleep mode
Put Unit To Sleep	Puts a selected unit that is currently in Normal operation mode to sleep

You can select specific units on the network to wake or put to sleep, as well as send a message that you type in the “Message” field.

AreaRAE Plus & AreaRAE Pro User's Guide

6.1.1 Send Message

Type a message that you want to send:

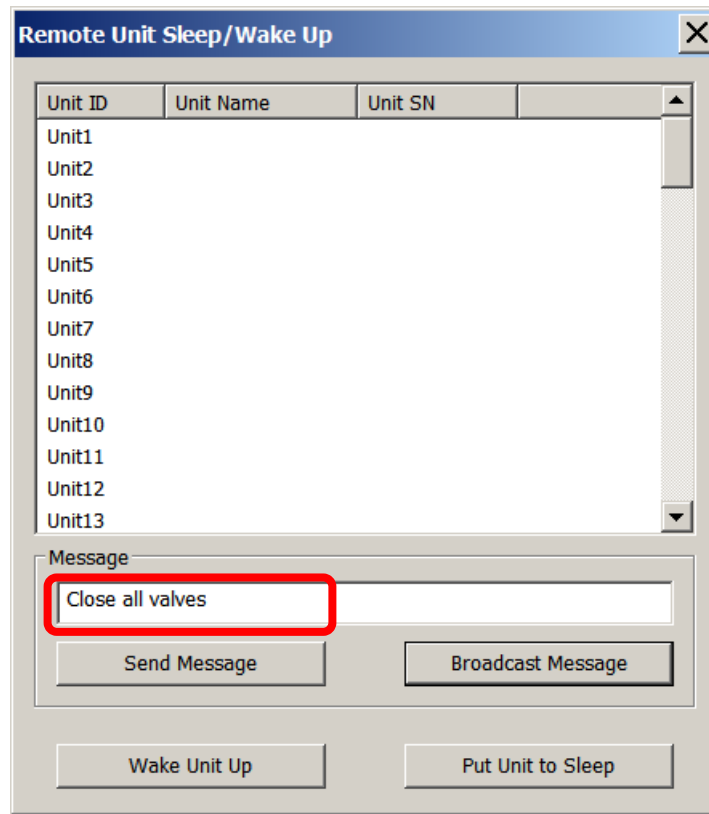

Click the name of an instrument that you want to send a message to:

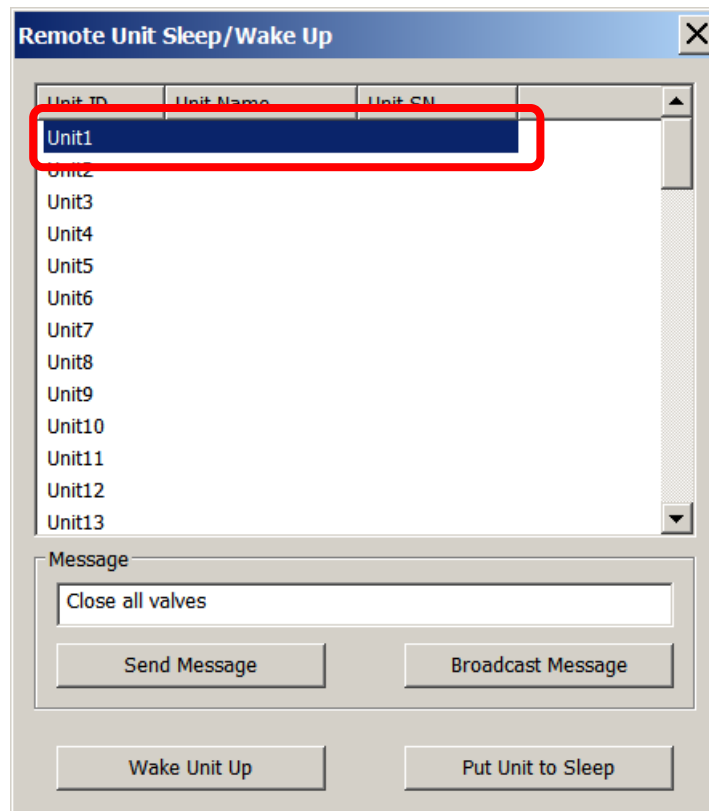

AreaRAE Plus & AreaRAE Pro User's Guide

Click "Send Message."

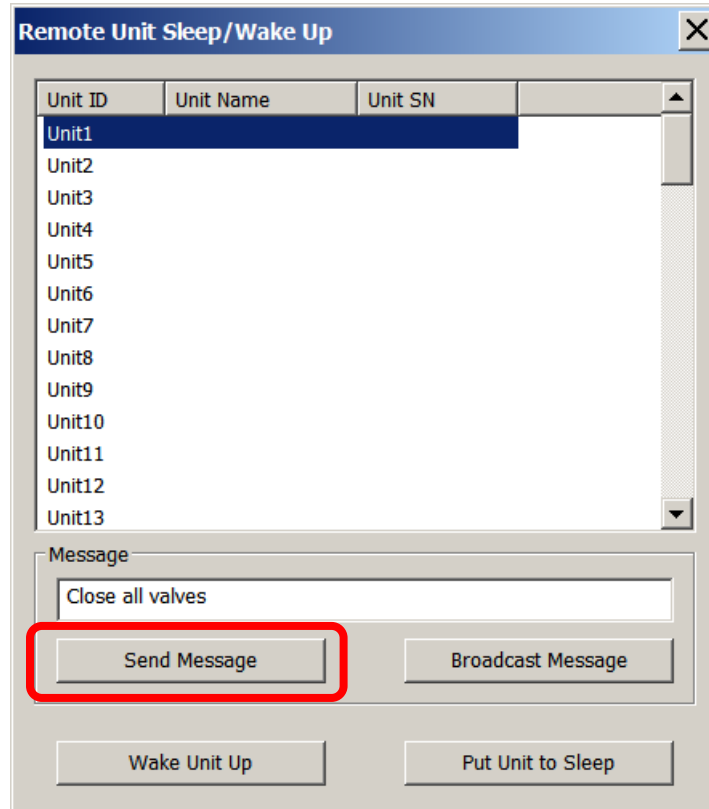

Any alarms (sound, lights) on the AreaRAE Plus/Pro will be triggered, and the message appears on its screen:

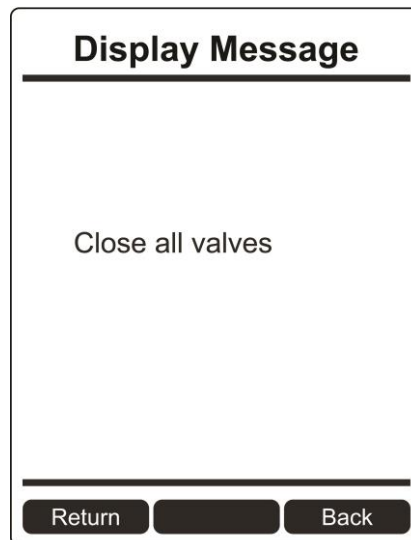

After 60 seconds, the message is cleared and the screen reverts to showing monitoring data.

Note: You can select multiple units to send to (Shift-Click to select sequential group, Control-Click to select individuals).

AreaRAE Plus & AreaRAE Pro User's Guide

6.1.2 Broadcast Message

From ProRAE Guardian, you can broadcast a message to all instruments on the network that accept messages.

1. Type a message into the “Message” field. **Note:** Each message is limited to 32 characters, including spaces.
2. Click “Broadcast Message.”

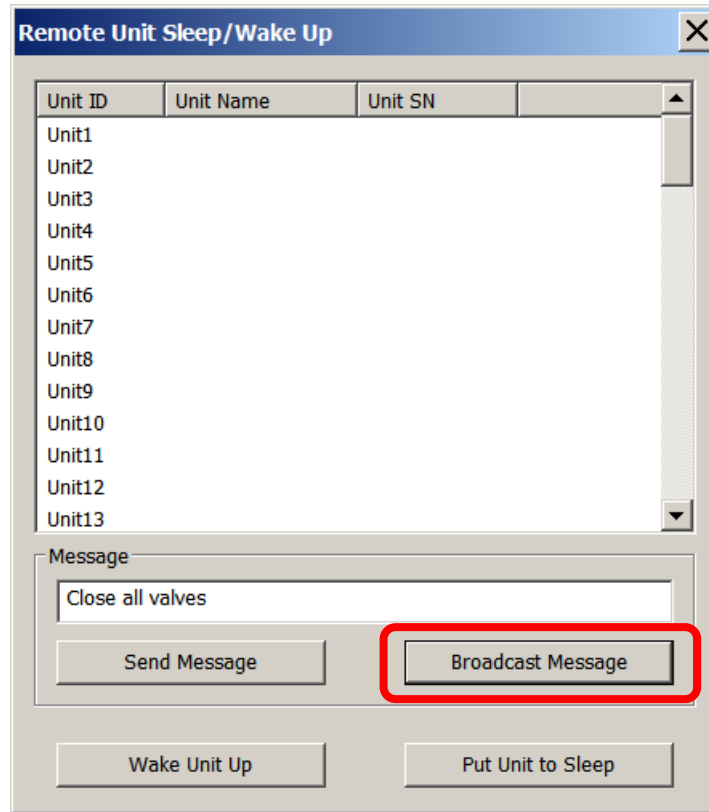

The message is broadcast to all instruments on the network that are capable of receiving messages.

AreaRAE Plus & AreaRAE Pro User's Guide

Any alarms (sound, lights) on the AreaRAE Plus/Pro will be triggered, and the message appears on all receiving instruments' screens:

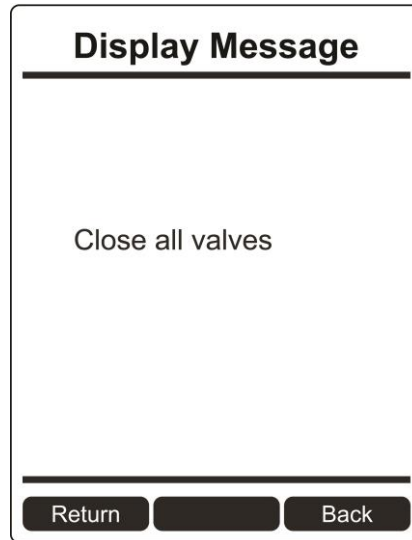

After 60 seconds, the message is cleared and the screen reverts to showing monitoring data.

6.1.3 View Messages In AreaRAE Plus/Pro

The AreaRAE Plus/Pro stores up to 10 received messages. To view messages:

1. Hold the [MODE] and [N/-] keys until you enter Programming Mode (a password may be required; see page 49 for details).
2. Select "Wireless."
3. Scroll down to "Message."
4. Click [Y/+] to select.

A list of messages, accompanied by date and time, is shown:

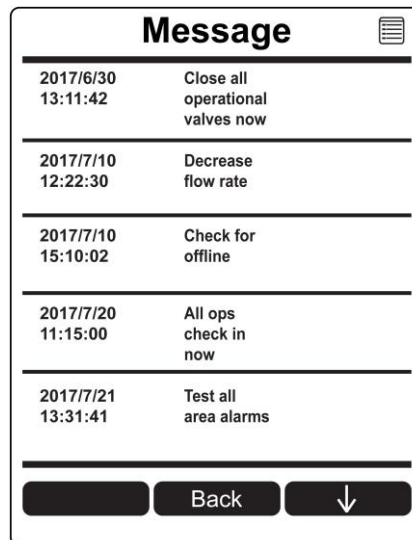

Note: You cannot delete messages directly in the AreaRAE Plus/Pro. You must connect the instrument to a PC running ProRAE Studio II, and then download the instrument's data to ProRAE Studio II. Refer to the ProRAE Studio II User's Guide for details.

AreaRAE Plus & AreaRAE Pro User's Guide

6.1.4 Wake Unit Up/Put Unit To Sleep

There are two ways to wake the ProRAE Guardian: On the instrument or from ProRAE Guardian.

6.1.5 Wake Unit Up (At Instrument)

When the AreaRAE Plus/Pro is in Sleep mode, the display is dark and no information is shown. To wake it:

1. Press any key on the instrument.
2. The "Password" screen is shown. Input the AreaRAE Plus/Pro's password:

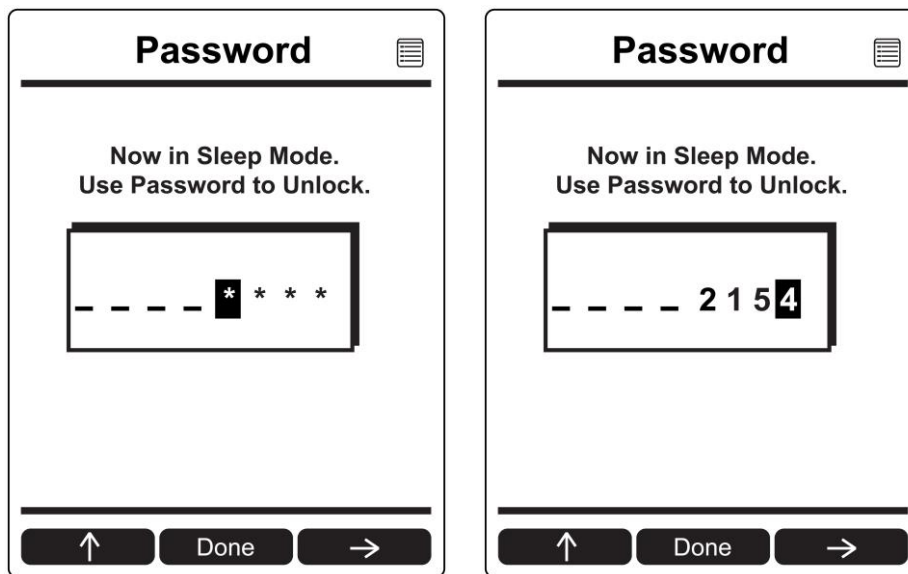

3. Click [MODE] when you are done.
- If the password is correct, the AreaRAE Pro starts up and is monitoring.
 - If the password is incorrect, the screen goes dark again. This is an anti-tampering feature.

AreaRAE Plus & AreaRAE Pro User's Guide

6.1.6 Wake Unit Up (From ProRAE Guardian)

If the AreaRAE Plus/Pro is on a network with ProRAE Guardian, you can wake it remotely from the same screen where you send messages.

1. Select the instrument you want to wake up.
2. Click “Wake Unit Up.”

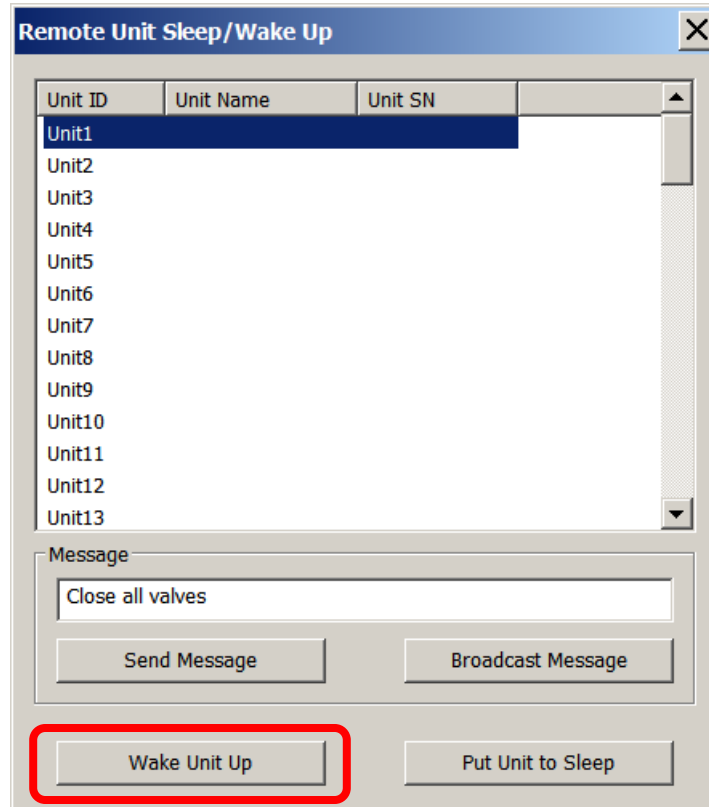

The instrument should wake up and begin monitoring immediately.

AreaRAE Plus & AreaRAE Pro User's Guide

6.1.7 Put Unit To Sleep (From ProRAE Guardian)

If the AreaRAE Plus/Pro is on a network with ProRAE Guardian, you can put it to sleep it remotely from the same screen where you send messages.

1. Select the instrument you want to put to sleep.
2. Click "Put Unit To Sleep."

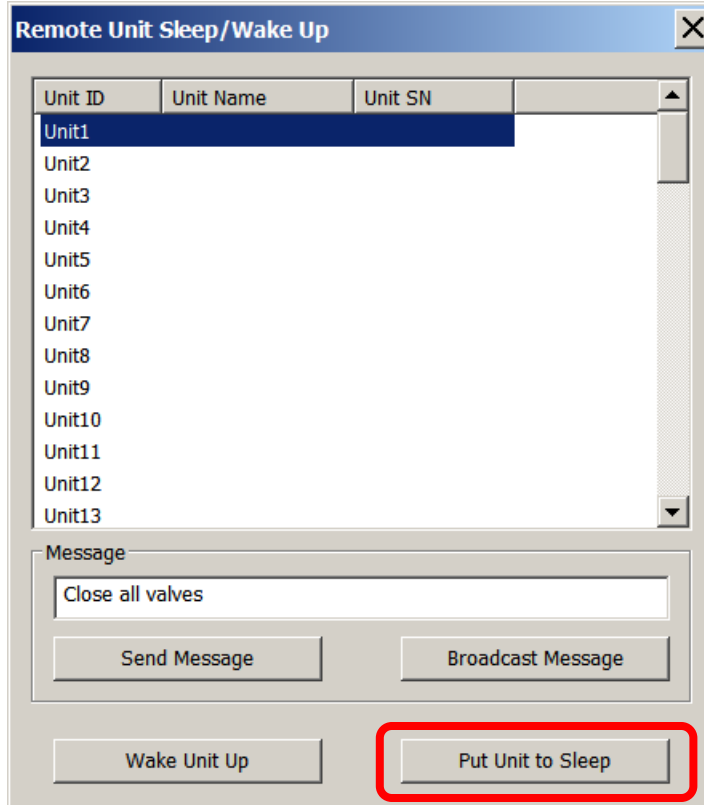

The instrument stops monitoring immediately, the pump shuts down, and the screen goes dark.

7 Wireless Control And Submenus

When you step through the main menu, as shown in the previous diagram, there are screens for wireless communication, including ISM, Wi-Fi, and Mesh radio.

In order to allow turning radios on or off in the AreaRAE Plus/Pro, you can use ProRAE Studio II to set the instrument in Advanced User Mode or Basic User Mode.

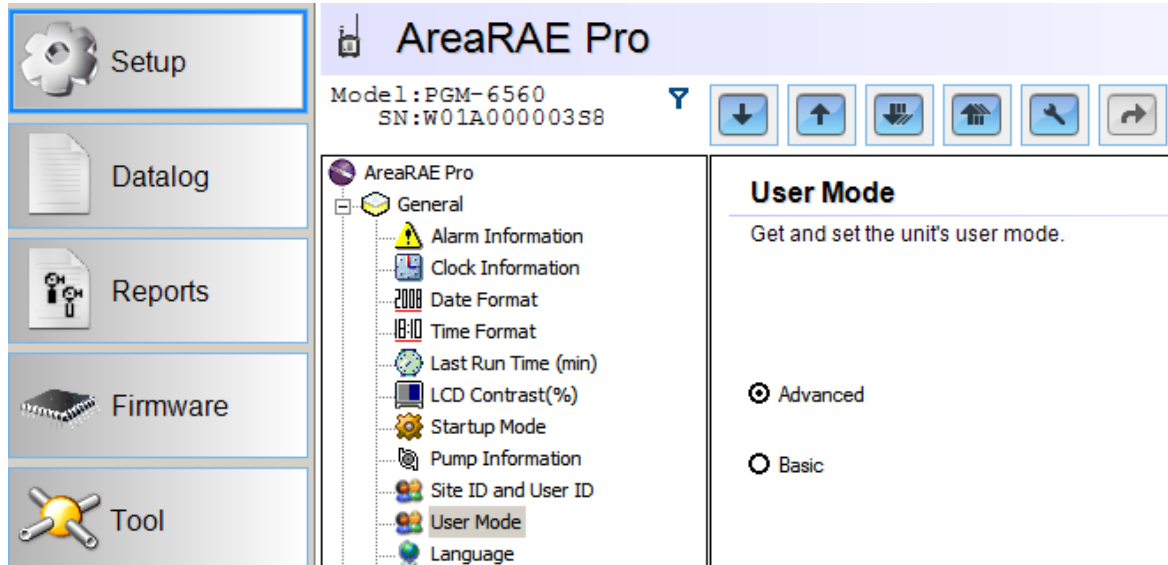

It is also necessary to select a Primary Modem if the AreaRAE Plus/Pro is equipped with both ISM and Wi-Fi modems.

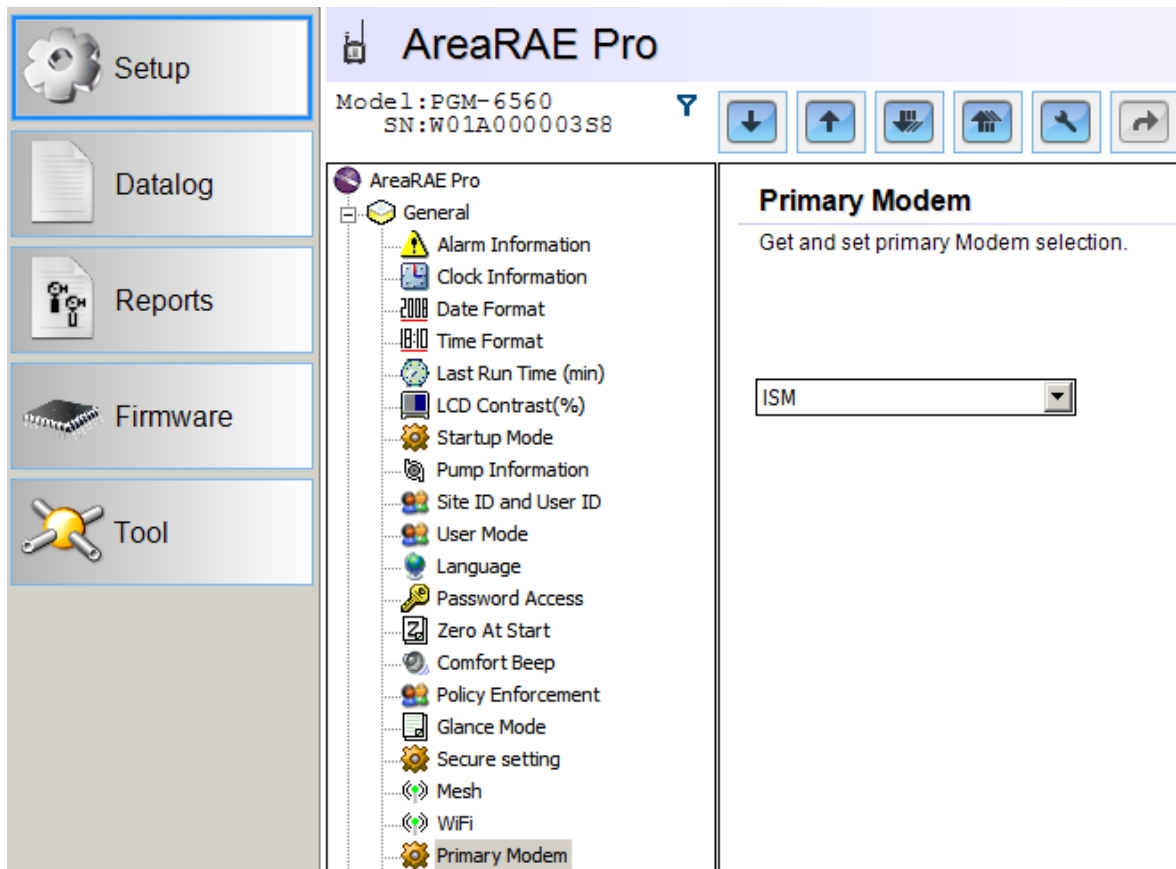

AreaRAE Plus & AreaRAE Pro User's Guide

7.1 ISM Settings

Every network using ISM radio must have a Network ID, which identifies that network and all equipment operating in that network. All AreaRAE Plus/Pro and RAELink3 (or other RAELink model) Host, Repeater, and Remote wireless modems in the same AreaRAE network need to be configured with the same Network ID. Each device on the network must have a unique Unit ID.

ISM

Get and set ISM parameters.

Power

Network ID (1-4095 and not 255)

Unit ID (1-64)

Note: ISM Settings can be adjusted in the AreaRAE Plus/Pro's Wireless menu under "ISM."

8 Wi-Fi Settings

AreaRAE Plus/Pro's Wi-Fi is designed to operate on a wireless network anchored by ProRAE Guardian monitoring software and using Wi-Fi access points. Operational distance between the instrument and the access point (wireless router) varies, depending on distance, interference, and obstacles. It uses the 802.11b protocol using the 2.4GHz ISM (license-free) frequency band.

Note: To ensure the best communication, it is recommended that the Wi-Fi-equipped instruments and access point not be located close to microwave ovens, cordless telephones, or Bluetooth devices.

8.1 Secure Wireless Access Point Configuration

If Wi-Fi is enabled, an AreaRAE Pro or AreaRAE Plus uses a Wi-Fi wireless network to transmit data related to its current and past activity. To protect these data against unauthorized access, Honeywell recommends the following when configuring your wireless network:

- Set a unique network name (SSID). Do not use the default name.
- Set unique administrative credentials (username and password) that control the configuration settings of your Access Point / Router / Gateway. Do not use the default credentials. Use a strong password (see Strong Password Tips).
- Configure strong authentication and encryption in your network. Honeywell recommends WPA2 Personal (aka WPA2-PSK) with AES encryption.
- Create a strong network passphrase (see strong password tips). Do not use the default passphrase.
- Maintain the firmware of your Access Point / Router / Gateway as well as the firmware of all devices connected to the wireless network up to date.

8.2 Setting Wi-Fi Communication Parameters In ProRAE Studio II

Wi-Fi-equipped instruments' parameters for communication must be set in ProRAE Studio II.

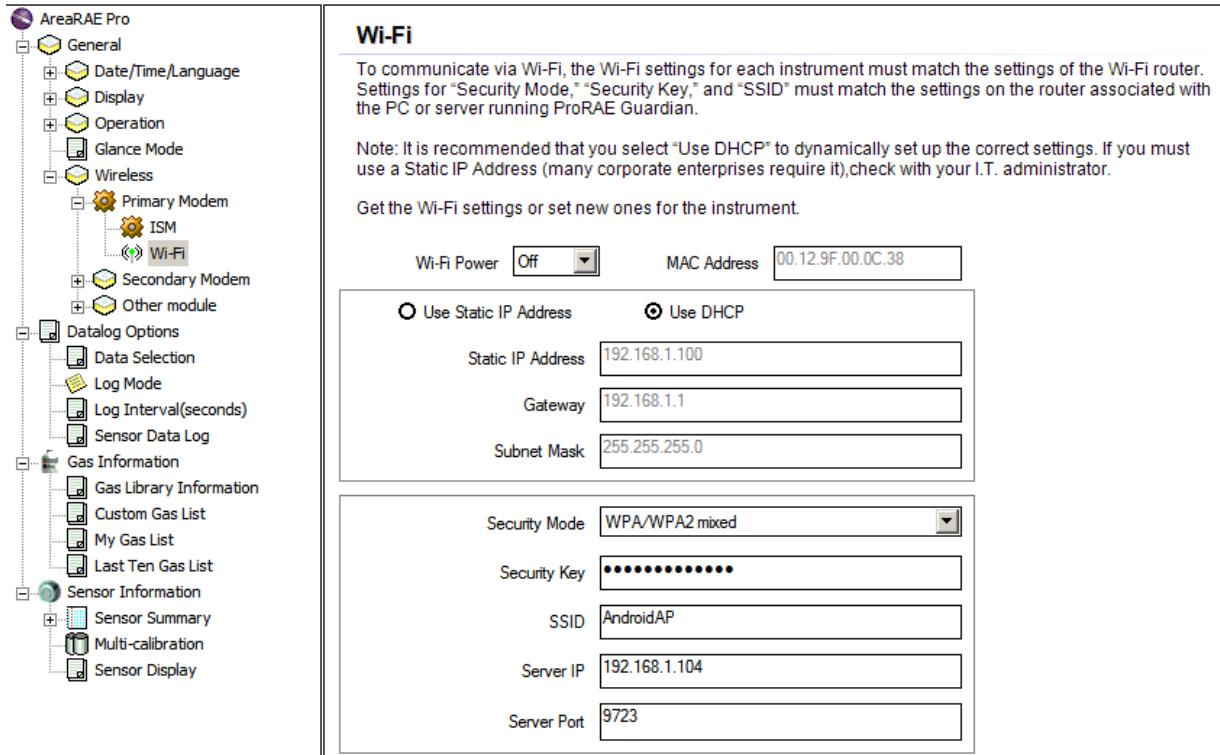

1. Connect Wi-Fi-equipped instrument via USB to a PC running ProRAE Studio II.
2. Place the AreaRAE Plus/Pro in Communications Mode.
3. From the main screen, press [N/-] until you see “Enter Communications Mode?”
4. Press [Y/+].
5. Select PC.

The message on the display should say “Ready To Communicate With Computer”.

1. Start ProRAE Studio II.
2. Log in using your Administrator's password.
3. Click the “Detect Instruments Automatically” icon.
4. When your Wi-Fi-equipped instrument is detected, click on its information and then click “Select”.
5. Click “Setup” to download the current settings from the Wi-Fi-equipped instrument. The main screen appears.
6. Find and click “Wi-Fi” in the list.



Wi-Fi parameters appear in the right pane.

You can now change settings for the Wi-Fi-equipped instrument. When you are done, click this icon to send the new settings to the instrument:



AreaRAE Plus & AreaRAE Pro User's Guide

8.2.1 Wi-Fi Power

Select either “On” or “Off” to set the default power setting for your Wi-Fi-equipped instrument.



Note: Wi-Fi Power can also be turned on or off in the AreaRAE Plus/Pro in the Wireless menu's “Wi-Fi.”

8.2.2 Address

Select “Use Static IP Address” if you have a static IP or “Use DHCP” if your system allows dynamic hosting configuration. Check with your system administrator to determine which is appropriate for your network.

If you use a static IP address, you must provide the Static IP address, Gateway, and Subnet Mask. If you are using DHCP, you do not have to provide these, because they will be filled in automatically.

8.2.3 Channels And Security

Check with your system administrator for the settings in this section.

8.2.4 Security Mode

Different types of wireless security guard your network against possible instances of unauthorized access. Using security, you can:

- Ensure that no one can easily connect to your wireless network without permission
- Personalize access regarding who can configure your wireless settings
- Protect all data that is transmitted through the wireless network

Check with your system administrator for the wireless security mode you should use.

Use the drop-down menu to select the type of security:

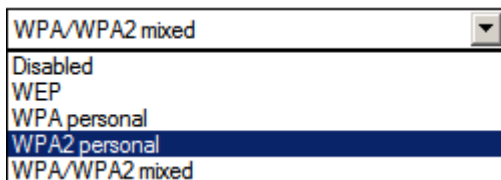

Then set your Security Key.

Warning! Using a network with security disabled is not recommended.

AreaRAE Plus & AreaRAE Pro User's Guide

8.2.5 Security Key

Depending on the type of security you choose, your key will have to be a different number of characters.

IMPORTANT!

Configure strong authentication and encryption in your network. WPA2 Personal (also known as WPA2-PSK) with AES encryption is highly recommended.

Here are characteristics of the different types, their relative security strength, and the number of characters needed in the key:

Security Type	Security Rank	Number of Characters
WEP (Wired Equivalent Protocol)	Basic	40/64-bit (10 characters) 128-bit (26 characters)
WPA Personal Wi-Fi Protected Access Personal	Strong	8 to 63 characters
WPA2 Personal Wi-Fi Protected Access 2 Personal	Strongest	8 to 63 characters
WPA2/WPA Mixed Mode	WPA2: Strongest WPA: Strong	8 to 63 characters

Strong Password Tips

- Use a unique password. Do not reuse passwords used in other systems or for other purposes. Avoid using examples found on the Internet, in literature etc.
- Use a long sequence of random characters (at least eight characters).
- Use a mix of different types of characters, such as uppercase and lowercase letters, numbers, punctuation marks, etc.
- To make the password easier to remember, begin with a sentence, verse, book title, line from a song etc. Omit or change certain letters. For example, use only the first few letters from each word, replace some letters with numbers or punctuation marks (for example replace all letters “a” with dots “.”), etc.
- Avoid using easily guessable phrases, like names, words found in dictionaries, years, birthdays, phone numbers, etc.
- Avoid using the most popular passwords, such as “123456”, “qwerty”, “password” etc. Also avoid using them even in modified formats, such as “QWERTY” or “Pa55vv0rD”.
- Protect the password while archived. Use trusted and properly configured password vaults for this purpose.

8.2.6 SSID

The SSID (Service Set Identifier) is a case-sensitive unique identifier attached to the header of packets sent over a wireless local-area network. Each wireless network in your range will have its own SSID. Consult with your IT department for the SSID.

8.2.7 Server IP

This is the destination IP address for the instrument to communicate with a computer running ProRAE Guardian.

8.2.8 Server Port

The port number is distinct from any physical port on a computer such as a COM port or an I/O port address. It is a 16-bit address that exists only for the purpose of passing certain types of information to the correct location above the transport layer of the protocol stack.

9 Relays For Controlling External Equipment

The AreaRAE Plus/Pro is equipped with three solid-state relays that are switched by gas sensor alarm conditions or by a pump failure. These relays are always active. All of the relays' contacts are protected against high in-rush current. The external alarms that are to be connected to the instrument must be suitable for the hazardous location where they are mounted, and supplied from a Class 2 power supply or equivalent. The wiring method shall be to local electrical code and installations are subject to acceptance by the authority having jurisdiction. They can be tested by accessing Diagnostic Mode.

WARNING!

EXPLOSION HAZARD. DO NOT CONNECT OR DISCONNECT UNLESS AREA IS KNOWN TO BE NON-HAZARDOUS.

Status: Normally Closed (default); can be changed to Normally Open by using ProRAE Studio II software.

Type: Dry Contact

Maximum voltage: 24VDC

Maximum amperage: 250mA

Relay contact rating: 24V, 250mA

Relays open to indicate High, Low, and Sensor or Pump Failure status. When there is a pump failure, Relay 3's state changes to activate an alarm.

Note: If an external device is not connected, keep the dust cap on the connector to protect the pins.

Important Information About Using Relays In Normally Open (NO) Mode

Setting the relays to Normally Open (NO) strongly impacts battery runtime, and can decrease total runtime by as much as 30%, due to added power requirements. Also, when the relays are set to Normally Open operation, it is extremely important to respect the maximum voltage/amperage requirements. Failure to operate within those parameters can result in damage to the relay(s) or void certification requirement compliance.

Pinout For Relay Port:

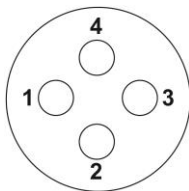

Pin1: COM (GND)

Pin2: Relay1 output

Pin3: Relay2 output

Pin4: Relay3 output

A mating connector for wiring to external devices is available from electronics distributors: Samtec part number ACP-16-03-G-00.30-S-BC-O-1.



AreaRAE Plus & AreaRAE Pro User's Guide

Test Setup For Relays:

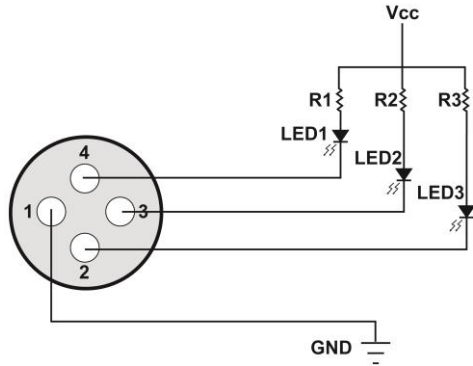

Relay Alarm Indications

Relay number	Alarm	Description	AreaRAE Plus/Pro Display
1	High, Over	Instant reading reaches the high/over limitation of any sensor installed	The text “Low,” “High,” “Fail,” “Lamp,” and “Over” flashes alongside the readings simultaneously. An alarm here points only to related sensors.
2	Low	Instant reading reaches the low limitation of any sensor installed	
3	Fail, Pump Stall	Any sensor in Fail alarm, VOC sensor in Lamp alarm, LEL sensor in Over alarm. Pump Stall alarm.	

IMPORTANT!

The external devices that are to be connected to the AreaRAE Plus/Pro must be suitable for the hazardous location where they are mounted.

The wiring method shall be to local electrical code and installations are subject to acceptance by the authority having jurisdiction.

AreaRAE Plus & AreaRAE Pro User's Guide

10 Battery

Always make sure the battery is fully charged before using the AreaRAE Plus/Pro. Only use this battery pack in the AreaRAE Plus/Pro (PGM-65XXX):

Standard-duration rechargeable Li-ion battery (PN: W01-3007-000 or W01-3007-100)

WARNING

To reduce the risk of ignition of hazardous atmospheres, recharge, remove or replace the battery only in an area known to be non-hazardous! Do not mix old and new batteries or batteries from different manufacturers.

10.1 Charging

Note: Batteries should be charged in an environment where the temperature is in the range of 32° to 104° F (0° to 40° C).

Follow this procedure to charge the AreaRAE Plus/Pro:

1. Remove the cover over the AreaRAE Plus/Pro's power port.

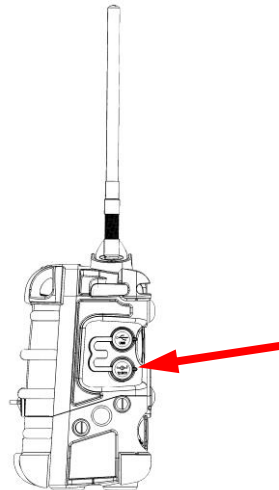

2. Plug the AC/DC adapter's barrel plug into the AreaRAE Plus/Pro's power port.

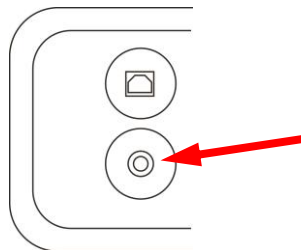

3. Plug the AC/DC adapter into the wall outlet.

The AreaRAE Plus/Pro begins charging automatically. The display shows that the battery is charging.

Green LEDs around the top of the AreaRAE Plus/Pro are used in Diagnostic mode.

AreaRAE Plus & AreaRAE Pro User's Guide

Charging *without* a VOC sensor installed: After the battery is fully charged, the display shows the charge when any key is pressed.





Charging *with* a VOC sensor installed: The AreaRAE Plus/Pro performs a VOC sensor auto-cleaning for 2 hours, and then it runs the pump for 20 minutes. The large battery icon is shown on the screen while auto cleaning is taking place.

IMPORTANT!

Always securely close the cover over the power port when not charging. This keeps moisture and debris out of the port.

10.2 Battery States

The battery icon on the display shows how much charge is in the battery and alerts you to any charging problems.

				
Full charge	2/3 charge	1/3 charge	Low charge	Battery alert

When the battery's charge falls below a preset voltage, the instrument warns you by beeping once and flashing once every minute, and the "empty battery" icon blinks on and off once per second. The instrument automatically powers down within 15 minutes, after which you will need to either recharge the battery, or replace it with a fresh one with a full charge.



10.3 External Battery Charger

You can charge a spare Li-Ion battery with the optional External Li-Ion Battery Charger For AreaRAE (P/N: W01-3005-000).

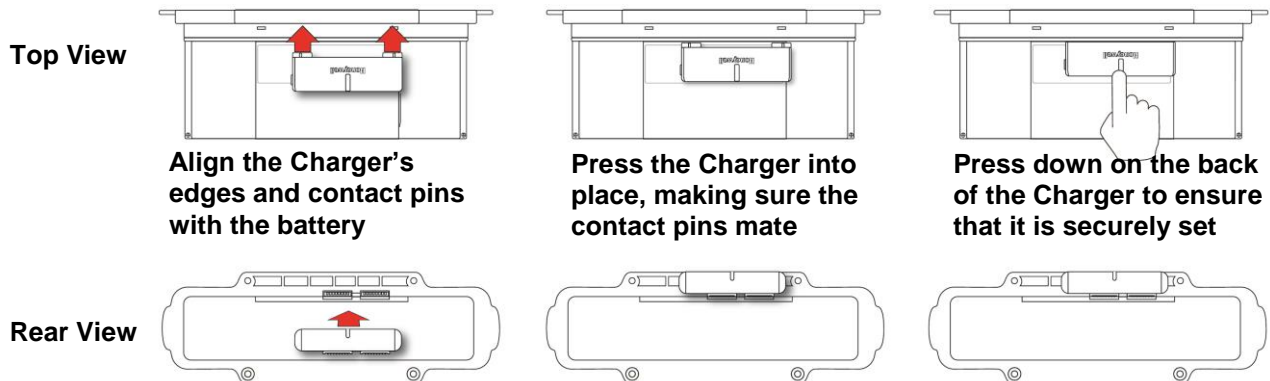

AreaRAE Plus & AreaRAE Pro User's Guide

Once the Charger is attached to the battery, plug in the AC adapter's barrel and then plug the power cord into an AC source.

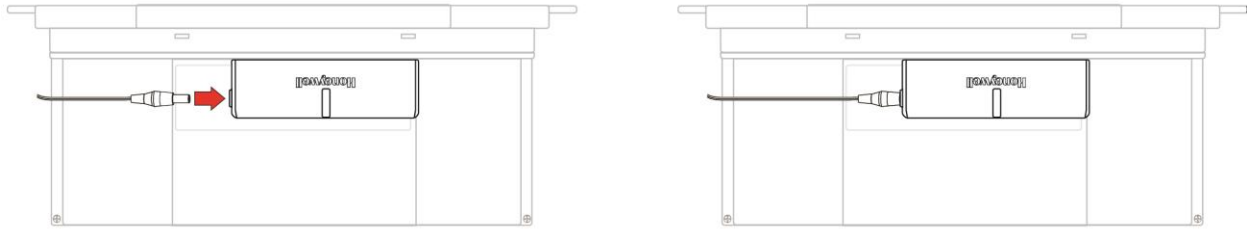

WARNING

To reduce the risk of ignition of hazardous atmospheres, recharge, remove or replace the battery only in an area known to be non-hazardous! Do not mix old and new batteries or batteries from different manufacturers.

10.3.1 External Battery Charger LED Indicators

LEDs on the External Battery Charger indicate the following:

LED	Indication
Solid red	NTC fault, bad battery, battery standby
Blinking red	Charging, but the capacity is too low to power the instrument (less than 10%)
Blinking green	Charging. The capacity is sufficient to power the instrument (more than 10%, but less than or equal to 99%)
Solid green	The LCD shows that the battery is fully charged when any button is pressed.

11 Turning The AreaRAE Plus/Pro On And Off

11.1 Turning The AreaRAE Plus/Pro On

With the instrument turned off, press and hold the [MODE] key until the beep sounds and the display and LED alarm lights turn on. Then release the [MODE] key.

A RAE Systems logo (or a company name) should appear first. This is followed by a progression of screens that tell you the AreaRAE Plus/Pro's current settings.

11.1.1 Pausing To View Screens During Startup

Press the [MODE] button anytime during the startup sequence to pause the progression. This allows you to view the information for as long as you like. To resume the progression, press [MODE] again. Even if you pause the progression of screens, the startup process is not interrupted.

Note: To speed up the startup time, the number of screens shown on startup can be reduced by enabling the Fast Startup option under Programming/Monitor.

Then the AreaRAE Plus/Pro's main reading screen appears. It displays instantaneous readings similar to the following screen (depending on the sensors installed) and is ready for use.

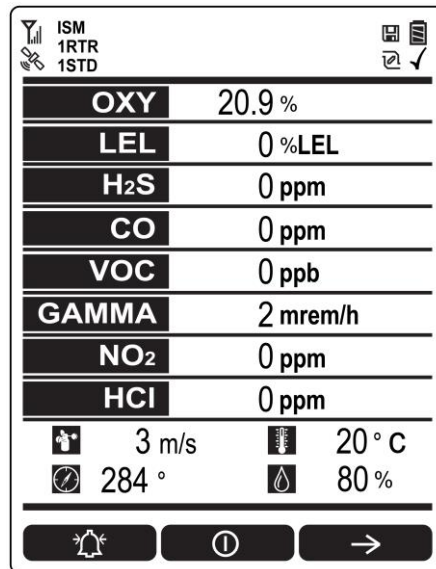

Note: If the battery is completely empty, then the display briefly shows the message “Battery Low,” and the AreaRAE Plus/Pro shuts off. You should charge the battery or replace it with a fully charged battery before turning it on again.

11.2 Turning The AreaRAE Plus/Pro Off

Press and hold [MODE]. A 5-second countdown to shutoff begins. You must hold your finger on the key for the entire shutoff process until the AreaRAE Plus/Pro is powered off.

11.3 Testing Alarm Indicators

Under normal-operation mode and non-alarm conditions, the buzzer, LEDs, and backlight can be tested at any time by pressing [Y/+] once.

IMPORTANT!

If any of the alarms does not respond to this test, check the Alarm Settings in Programming Mode. It is possible that any or all of the alarms have been turned off. If all of the alarms are turned on, but one or more of them (buzzer or LED lights) does not respond to this test, do not use the instrument. Contact your RAE Systems distributor for technical support.

11.4 Pump Status

IMPORTANT!

During operation, make sure the probe inlet and the gas outlet are free of obstructions. Obstructions can cause premature wear on the pump, false readings, or pump stalling. During normal operation, the pump icon alternately shows inflow and outflow as shown here:



If there is a pump failure or obstruction that disrupts the pump, the alarm sounds and you see this icon blinking on and off:



Once the obstruction is removed, you can try to restart the pump by pressing the [Y/+]. If the pump does not restart, and the pump stall alarm continues, consult the Troubleshooting section of this guide or contact RAE Systems Technical Support.

It is advisable to perform a pump stall test periodically, to make sure the pump is working properly and there are no leaks in the system. To perform a pump stall test, simply block the gas inlet with your finger. To pass the test, the instrument should go into a pump alarm. Press [Y/+] to disable the alarm and return to normal operation.

Note: For all AreaRAE Plus/Pro instruments with a PID, if the pump is in alarm for more than five minutes, the PID lamp automatically turns off. The display shows a “Lamp” alarm. Click [Y/+] to restart the pump. If there is no longer a pump alarm, then the PID lamp will require a 2-minute warm-up to stabilize. During this time, the PID’s reading shows “- - -”. Once the PID lamp is warmed up, the display shows the actual value.

Note: When a pump alarm occurs and the AreaRAE Plus/Pro is monitored by ProRAE Guardian, the PID’s reading in ProRAE Guardian shows “- - -”.

11.5 Calibration Status

The instrument displays this icon next to the sensor that requires calibration:



Calibration is required (and indicated by this icon) if:

- The lamp type has been changed.
- The sensor module has been replaced with one whose calibration is overdue.
- The defined period of time between calibrations has been exceeded.

AreaRAE Plus & AreaRAE Pro User's Guide

- If you have changed the calibration gas type without recalibrating the instrument.
- The sensor has failed a previous calibration.

11.6 Bump Status

The instrument displays this icon next to the sensor that requires bump test:



A bump test is required (and indicated by this icon) if:

- The defined period of time between bump tests has been exceeded (bump test overdue).
- The sensor has failed a previous bump test.
- The sensor(s) should be challenged on a periodic basis.

12 Programming

The menu in Programming Mode is to adjust settings, and calibrate sensors. It has the following submenus:

- Measurement
- Alarms
- Datalog
- Wireless
- Monitor
- Calibration

12.1 Enter Programming In Basic Mode

Programming in Basic Mode is limited to calibration only. A password is required to access other programming menus.

1. To enter Programming Mode, press and hold [MODE] and [N/-] until you see the Password screen.

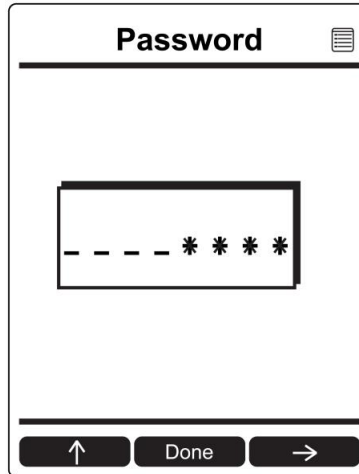

2. Input the 4-digit password:

- Increase the number from 0 through 9 by pressing [Y/+].
- Step from digit to digit using [N/-].
- Press [MODE] when you are done.

If you make a mistake, you can cycle through the digits by pressing [N/-] and then using [Y/+] to change the number in each position.

Note: The default password is 0000.

Note: The password screen appears when you enter the Programming Mode the first time after turning the instrument on in Basic Mode, and each time after that.

AreaRAE Plus & AreaRAE Pro User's Guide

Once you enter Programming Mode, the Calibration menu is highlighted. You cannot access other menu items, and you can only perform the following types of calibration:

- Fresh Air
- Multi Sensor Span
- Single Sensor Zero
- Single Sensor Span

The following require password access in Basic Mode or can be directly accessed in Advanced Mode.

- Multi Sensor Bump
- Single Sensor Bump
- Cal. Reference
- Change Cal. Gas
- Multi Cal Select
- Change Span Value

To enter a menu and view or edit parameters in its submenus, press [Y/+].

12.2 Enter Programming In Advanced Mode

1. To enter Programming Mode, press and hold [MODE] and [N/-] until you see the Calibration screen. No password is necessary in Advanced Mode.
2. Press [N/-] to step through the programming screens.
Note: Holding down [N/-] advances quickly through the menu options.

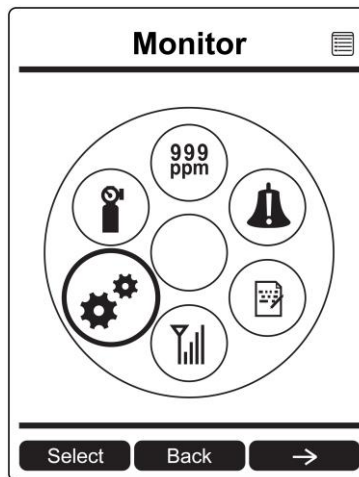







When a menu item is selected, its name is shown at the top of the screen, and its icon is enlarged.

To enter a menu and view or edit parameters in its submenus, press [Y/+].

AreaRAE Plus & AreaRAE Pro User's Guide

12.3 Menus And Submenus

In Programming Mode, menus and submenus are organized as shown here:

					
Calibration	Measurement	Alarms	Datalog	Wireless	Monitor
Fresh Air	Sensor On/Off	Alarm Limits	Clear Datalog	Sel Primary Radio	LCD Contrast
Multi Sensor Span	Change Meas. Gas	Alarm Mode	Datalog Interval	GPS	Zero At Start
Single Sensor Zero	Measurement Unit	Alarm Settings	Sensor Selection	Mesh	Fast Startup
Single Sensor Span		Comfort Beep	Data Selection	ISM	Language
Multi Sensor Bump			Datalog Type	Wi-Fi	Site ID
Single Sensor Bump			Memory Full Action	Message*	User ID
Cal. Reference					Secure In Place
Change Cal. Gas					
Multi Cal. Select					
Change Span Value					
Change Span 2 Value**					

* “Message” menu item appears only when messages have been received by the AreaRAE Plus/Pro.

** 7R+ sensors and 4R+ ppb sensors

12.3.1 Editing And Selecting Parameters And Sensors

There are a few basic ways to edit parameters, select sensors, and perform other activities in the AreaRAE Plus/Pro. The actions performed by pressing keys always match 1-to-1 with the boxes along the bottom of the display and the three keys. Some parameters are edited by scrolling and selecting individual items (black bars behind white text act as highlighters). Some include a choice via “radio buttons,” where only one item in a list can be selected, while other menus use boxes for you to “check” with an “X,” and these allow for multiple items in a list to be selected. In all cases of editing, you can save or undo your choice.

AreaRAE Plus & AreaRAE Pro User's Guide

12.3.2 Calibration

Use this menu to perform a bump test or zero or span calibration for one or more sensors, and change the gas concentration value used in bump tests and span calibration, as well as choose which sensors will be calibrated at the same time.

12.3.2.1. Fresh Air

This procedure determines the zero point for all the sensors that require a zero calibration. For the oxygen sensor, Fresh Air calibration sets the point equal to the concentration of oxygen in ambient air (approximately 20.9% volume).

Note: Fresh air calibration is performed on all enabled gas sensors at the same time.

To perform Fresh Air calibration on multiple sensors:

1. Connect the instrument's inlet to a source of dry, clean ambient air.
2. At the Calibration Menu, select "Fresh Air." Press [Y/+] once to enter the fresh air calibration sub-menu.
3. Start the flow of dry zero air, if used.
4. Press [Y/+] to start fresh air calibration.
5. A countdown screen appears. You can abort the calibration at any time during the countdown by pressing [N/-].

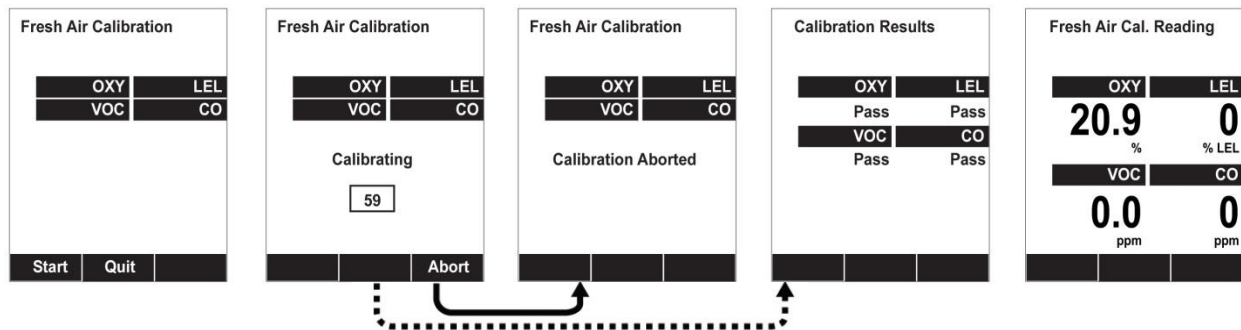

Note: Dotted line indicates automatic progression.

6. If the calibration is not aborted, the display shows the sensor names and tells you whether the fresh air calibration passed or failed, followed by the sensors' fresh air readings.

12.3.2.2. Multi Sensor Span

Depending on the configuration of your AreaRAE Plus/Pro and the span gas you have, you can perform a Span calibration simultaneously on multiple sensors.

The selected sensors are shown on the screen, along with the concentration settings for their Span gas. With calibration gas connected to the instrument, start a multi span by applying gas to the instrument. Calibration should start after a few seconds. If not, press [Y/:]. If you do not want to perform a multi span, press [MODE].

Note: You can abort a multi span by pressing [N/-] once testing has started.

When the Multi Span is done, a screen is shown, with the sensor names and either "Pass" or "Fail" shown next to them.

AreaRAE Plus & AreaRAE Pro User's Guide

12.3.2.3. Single Sensor Zero

This allows you to perform zero (fresh air) calibration on individual sensors. Even though most toxic gas sensors can be zeroed in fresh air, some sensors such as a parts-per-billion PID sensor for volatile organic compounds (VOCs) should not be zeroed in fresh air. VOCs are normally present in ambient air, so zeroing these sensors in ambient air will not allow for a true zero to be set for such sensors. The parts-per-billion PID sensor with should only be zeroed with zero air or in ambient air using a charcoal filter or a VOC zeroing tube.

1. If you are using a charcoal filter, connect it to the instrument.
2. If you are using dry air, connect the instrument to a source of zero air.
3. At the Calibration Menu, select “Single Sensor Zero.” Press [Y/+] once to enter the zero calibration sub-menu.
4. Start the flow of zero air, if used.
5. Press [Y/+] to start zero calibration.
6. A countdown screen appears. You can abort the calibration at any time during the countdown by pressing [N/-].

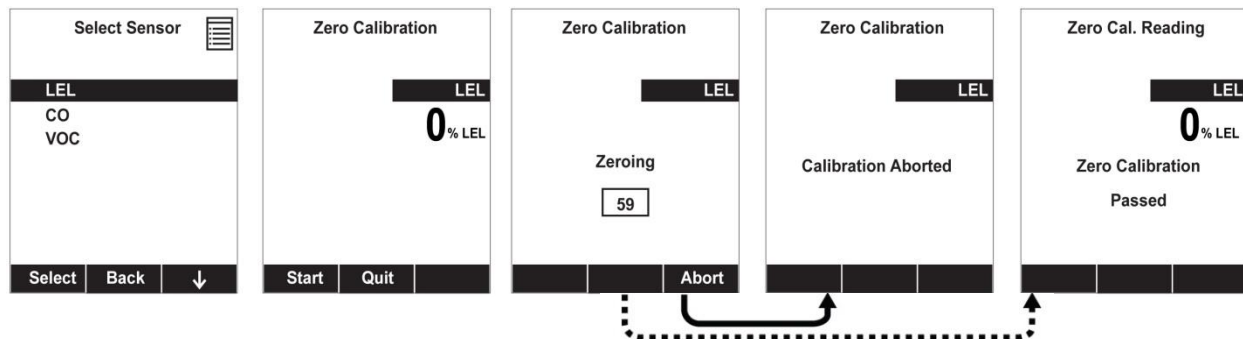

Note: Dotted line indicates automatic progression.

7. If the calibration is not aborted, the display shows the sensor names and tells you whether the zero calibration passed or failed, followed by the sensors' zero calibration readings.

AreaRAE Plus & AreaRAE Pro User's Guide

12.3.2.4. Single Sensor Span Calibration

Instead of performing a span calibration on multiple sensors simultaneously, you can select a single sensor and perform a span calibration.

Note: If a calibration icon (bottle with bottom portion filled in) is shown next to any of the sensors, it means that the sensor is due for a full calibration.

To perform span calibration of an individual sensor, follow these steps:

1. At the Calibration Menu, select “Single Sensor Span.”
2. Select a sensor to calibrate from the list.
3. Install the “T” tube and connect it to a source of calibration gas.
4. Verify that the displayed calibration value meets the concentration specified on the gas cylinder.
5. Start the flow of calibration gas.

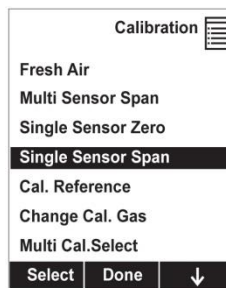

6. Press [Y/+] to start calibrating or wait for calibration to start automatically.
7. A countdown screen appears. You can abort the calibration at any time during the countdown by pressing [N/-].

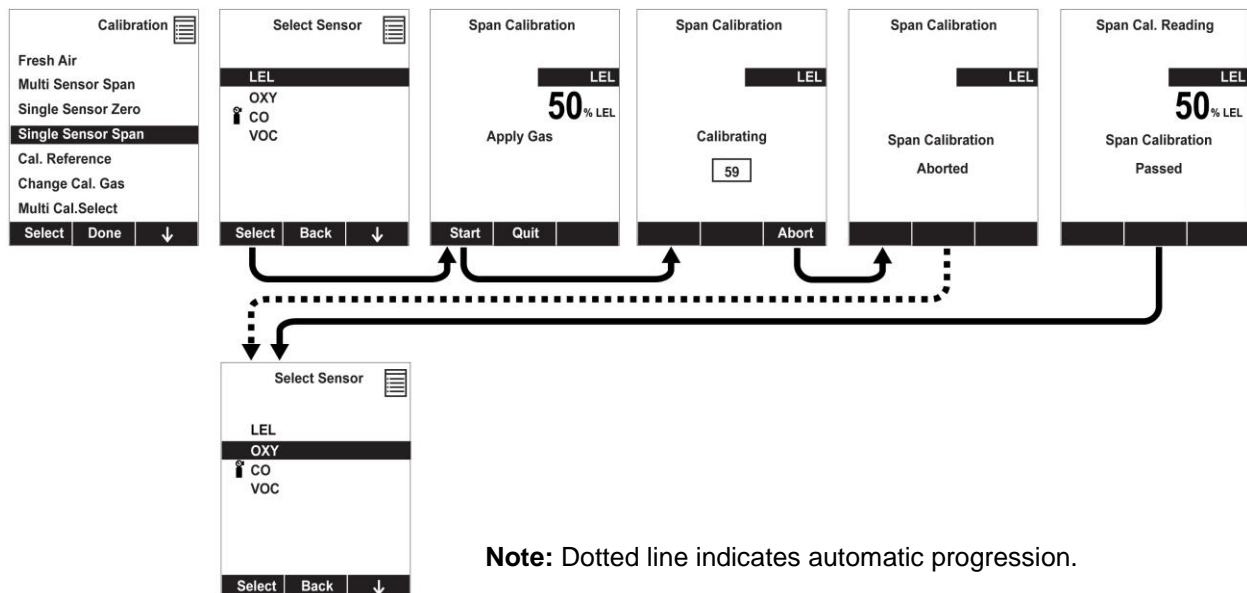

Note: Dotted line indicates automatic progression.

8. If the calibration is not aborted, the display shows the sensor names and tells you whether the calibration passed or failed, followed by the sensor readings.

AreaRAE Plus & AreaRAE Pro User's Guide

Note: The gamma radiation sensor comes pre-calibrated from the factory and does not require routine calibration. However, you can check it by placing a check-source on the rear of the AreaRAE Plus/Pro equipped with a gamma sensor to check the readings. Place the check-source near the upper middle of the rear of the instrument and hold it until you see the Gamma reading change in the display.

12.3.2.5. Single Sensor Span 2 Calibration

If the sensor is configured to allow a second calibration, after the first span calibration the display provides a prompt. With a label of “Span 2 Calibration,” it says, “Calibrate?” If you want to perform a second calibration, attach calibration gas to the “T” tube, start the flow, and calibrate just like the first span calibration.

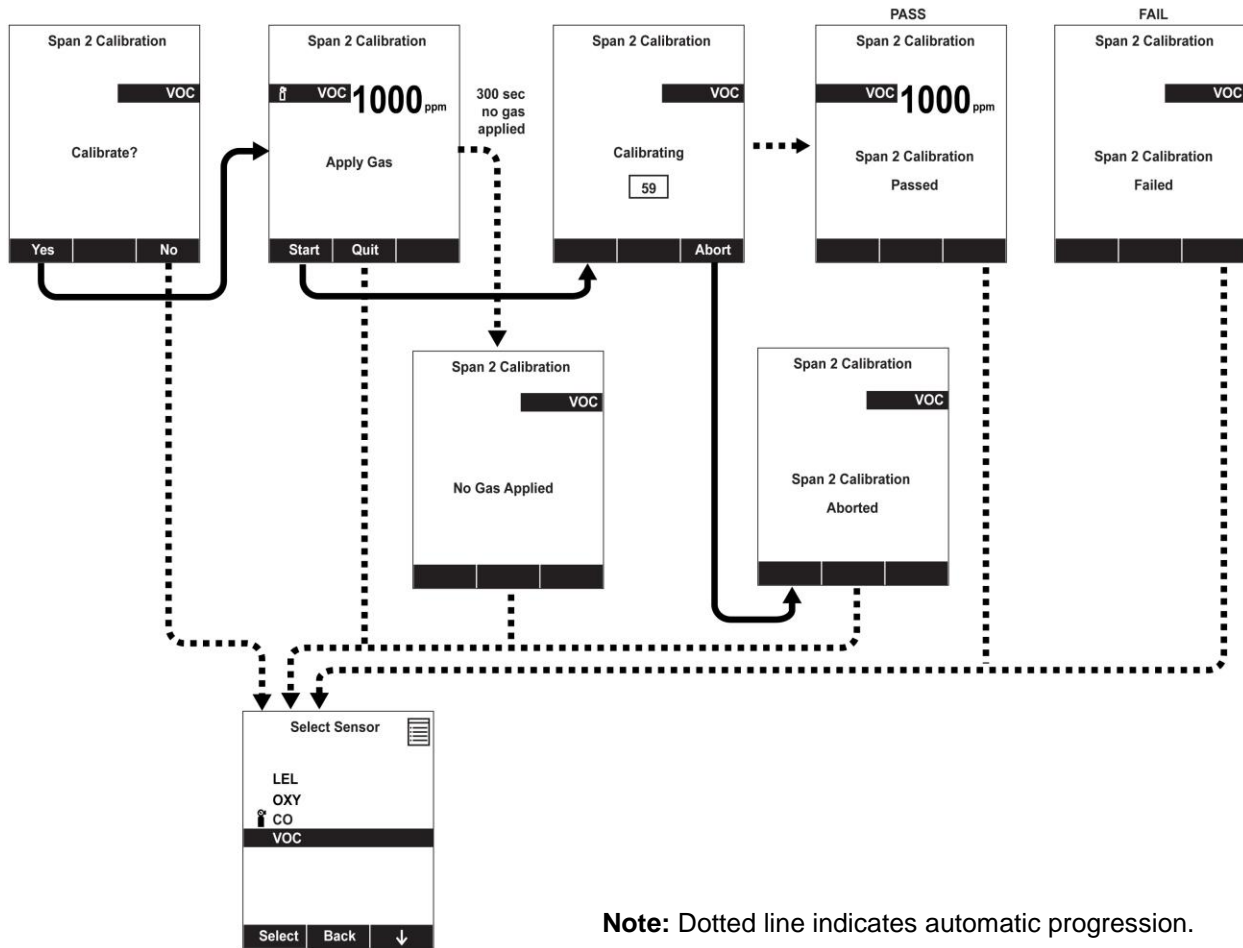

12.3.2.6. Multi Sensor Bump

Depending on the configuration of your AreaRAE Plus/Pro and the span gas you have, you can perform a bump test simultaneously on multiple sensors.

The selected sensors are shown on the screen. With calibration gas connected to the instrument, start a multiple bump test by applying gas to the instrument and pressing [Y/+]. If you do not want to perform a multiple bump test, press [MODE].

Note: You can abort a multiple bump test by pressing [N/-] once testing has started.

When the Multi Bump test is done, a screen is shown, with the sensor names and either “Pass” or “Fail” shown next to them.

AreaRAE Plus & AreaRAE Pro User's Guide

12.3.2.7. Single Sensor Bump

This menu allows a bump test to be performed on an individual sensor of your choice.

Note: If a bump test icon (bottle with bottom portion not filled in) is shown next to any of the sensors, it means that the sensor is due for a bump test.



To perform a bump test on an individual sensor, follow these steps:

1. At the Calibration Menu, select “Single Sensor Bump.”
2. Scroll down the list using [N/-], and then press [Y/+] to select a sensor to bump test.
3. Install the “T” tube and connect it to a source of calibration gas.
4. Verify that the displayed calibration value meets the concentration specified on the gas cylinder.
5. Start the flow of calibration gas.

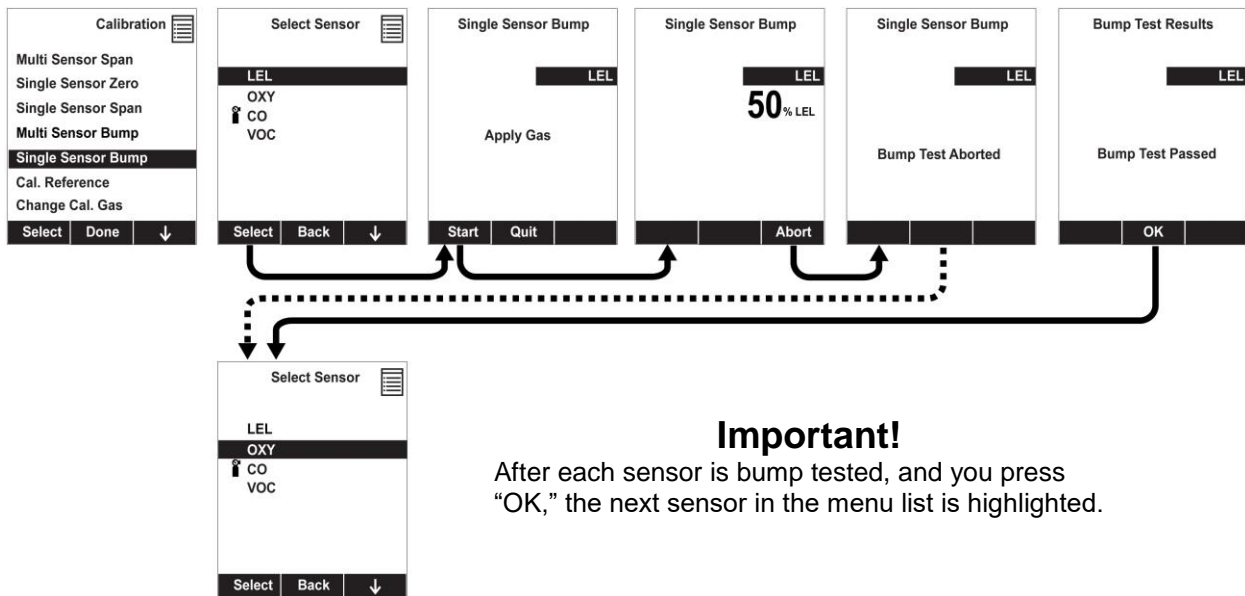

Note: Dotted line indicates automatic progression.

6. Press [Y/+] to start calibrating or wait for the bump test to start automatically.
7. A countdown screen appears. You can abort the bump test at any time during the countdown by pressing [N/-].
8. If the bump test is not aborted, the display shows the sensor names and tells you whether the bump test passed or failed, followed by the sensor readings.

AreaRAE Plus & AreaRAE Pro User's Guide

12.3.2.8. Cal. Reference

It is sometimes desirable to calibrate a sensor (PID for VOC, and LEL) with a specific gas for best response to a gas you are surveying. The Cal. Reference library contains a list of reference gases that can be selected for the PID and LEL sensors. Choose the sensor, and then select from the list of reference gases.

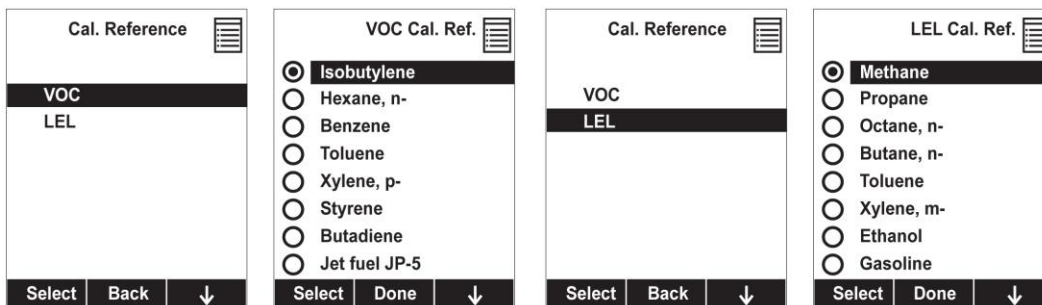

12.3.2.9. Change Cal. Gas

You can change the calibration gas for the AreaRAE Plus/Pro's PID and LEL sensors. Select from a custom list that you create (My List), the last ten gases used, the built-in gas library for your PID lamp, and user-defined custom gases. Each gas is shown in the list for selection and the screen automatically changes to show its full name, chemical formula, molecular weight (M.W.) and correction factor (CF).

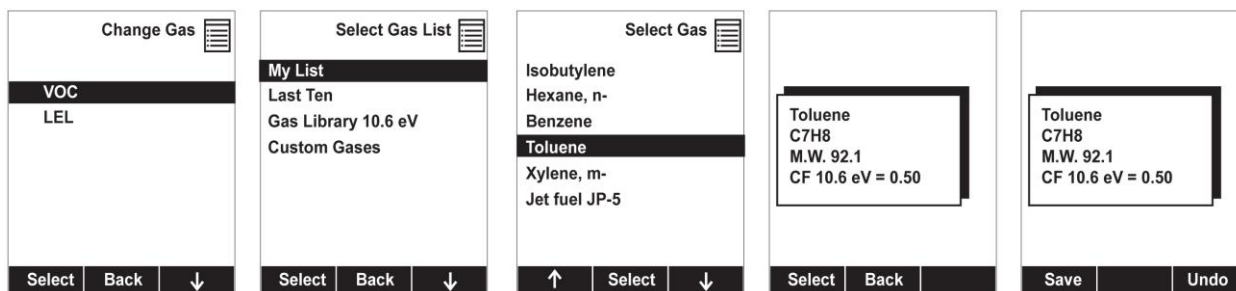

12.3.2.10. Multi Cal. Select

This menu allows you to define a group of sensors to be bump tested and span calibrated together. Simultaneous testing and calibration of multiple sensors shortens the bump test and calibration processes and reduces the number of individual gas cylinders you need. For example, it may be more efficient to use a single cylinder with a four-gas mix including 50% LEL Methane, 18% O₂, 10 ppm H₂S, and 50 ppm CO, to calibrate the LEL, O₂, CO, and H₂S sensors at one time, compared to using four distinct gas cylinders and calibrate these sensors individually in sequence. In order for sensors to be calibrated together, all of them must be selected using Multi Cal. Select.

1. Scroll down the list of sensors using the [N/-] key.
2. Add or remove that gas from the list by pressing [Y/+]. An "X" in a box to the left of a sensor's name indicates it is selected.
3. Once you have made all your selections, press [MODE] for "Done."

AreaRAE Plus & AreaRAE Pro User's Guide

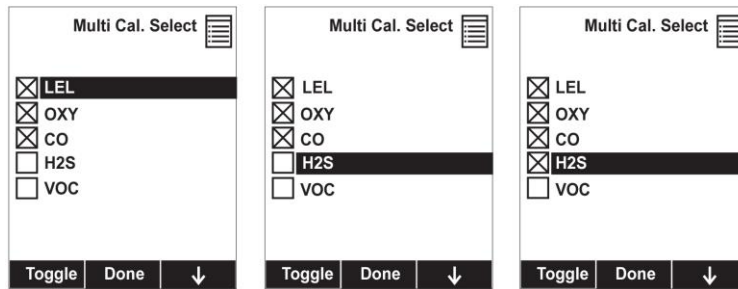

12.3.2.11. Change Span Value

You can individually set the span gas concentration for each sensor. This concentration setting will also be used for a bump test. The units of measure (ppm, %LEL, etc.) are shown on the display.

1. Scroll down the list of sensors using the [N/-] key.
2. Press [Y/+] to select it.
3. Press [N/-] to step through the digits.
4. Press [Y/+] to increase the number from 0 through 9. Once the number 9 is reached, pressing [Y/+] causes the numbers to “wrap around” to 0 and count up again.
5. Once you have set the desired value, press [MODE] for “Done.” This registers the new span value.

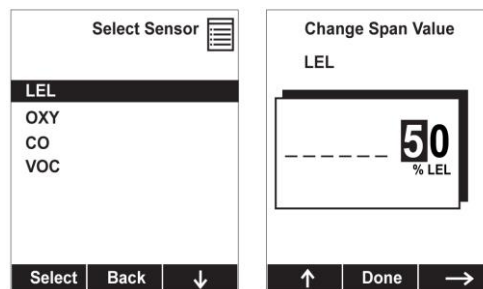

12.3.2.12. Change Span 2 Value

For enhanced accuracy, it is possible to perform a second Span calibration in addition to Zero and Span calibrations. Your instrument first must be set to allow this third calibration. This requires using ProRAE Studio II software and a PC, as well as a higher concentration of calibration gas. **Note:** 3-point calibration is the default for AreaRAE Pro for ppb resolution or the high range (0 to 5,000 ppm). For other configurations, 2-point calibration is the default.

Note: You can only disable 3-point calibration capability by using ProRAE Studio II again.

1. Press [Y/+] to select VOC.
2. Press [N/-] to step through the digits.
3. Press [Y/+] to increase the number from 0 through 9. Once the number 9 is reached, pressing [Y/+] causes the numbers to “wrap around” to 0 and count up again.
4. Once you have set the desired value, press [MODE] for “Done.” This registers the new second span value.
5. Press [Y/+] for “Save” and [N/-] for “Undo.”

AreaRAE Plus & AreaRAE Pro User's Guide

12.3.3 LEL Calibration Procedure

You must perform a separate zero calibration for the LEL sensor and then perform a span calibration.

Important! Before calibrating, make sure pump is on its high setting. This is in the “Pump Speed” submenu under the “Monitor” menu item.

To calibrate the LEL sensor, follow these two procedures:

12.3.3.1. Zero Sensor Calibration For The LEL Sensor

1. Turn on the AreaRAE Plus/Pro and allow it to warm up for 20 minutes in ambient air.
2. In Programming mode, Select “Calibration” and then select “Single Sensor Zero.”
3. Select “LEL.”
4. Calibrate the LEL sensor's zero point with ambient air.
5. After zero calibration is complete, press [MODE] to return to the Calibration menu. “Single Sensor Span” is highlighted

12.3.3.2. Span Calibration For The LEL Sensor

1. Press [Y/+] to select “Single Sensor Span.”
2. Press [N/-] until “LEL Sensor” is highlighted.
3. Press [Y/+] to select “LEL Sensor.”
4. Screw one end of a “T” using Teflon tubing to the AreaRAE Plus/Pro filter on the inlet. (You can use RAE Systems P/N: W01-3003-000).

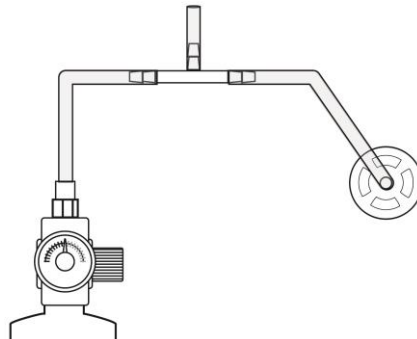

5. Attach the other end to the flow regulator of a calibration cylinder with 50% LEL methane (unless otherwise specified). The flow rate should not be less than 750cc/min.
6. Start the flow of calibration gas.
7. Press [Y/+] to start calibration.
8. When calibration is complete, shut off the calibration gas flow and disconnect the calibration tubing.
9. Press [MODE] to exit to the menu. (You may perform other calibrations. Otherwise, exit.)

AreaRAE Plus & AreaRAE Pro User's Guide

12.3.4 Measurement

The submenus for Measurement include Sensor On/Off, Change Measurement Gas, and VOC and Gamma (if equipped) Measurement Units.

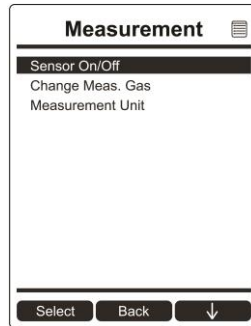

12.3.4.1. Sensor On/Off

You can turn sensors on or off via this submenu. An “X” in a box to the left of a sensor’s name indicates it is turned on.

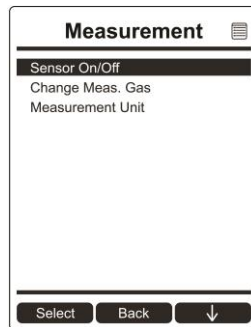

1. Scroll down the list of sensors using the [N/-] key.
2. Add or remove that gas from the list by pressing [Y/+]. An “X” in a box to the left of a sensor’s name indicates it is selected.
3. Once you have made all your selections, press [MODE] for “Done.”

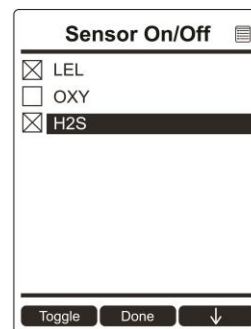
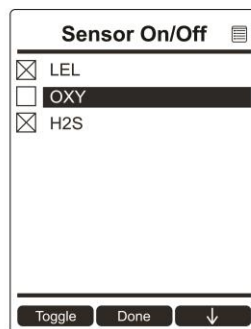
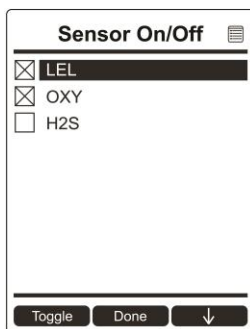

AreaRAE Plus & AreaRAE Pro User's Guide

12.3.4.2. Change Meas. Gas

The AreaRAE Plus/Pro has extensive onboard gas libraries for combustible gases and VOCs that you can use to configure your AreaRAE Plus/Pro to automatically apply the appropriate correction factors and produce readings in the units of the desired combustible gas or VOC.

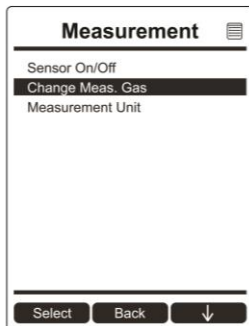

Measurement gases are organized in four lists:

- **My List** is a customized list of gases that you create. It contains a maximum of 10 gases and can only be built in ProRAE Studio II on a PC and transferred to the instrument.
Note: The first gas in the list is always isobutylene (it cannot be removed from the list).
- **Last Ten** is a list of the last ten gases used by your instrument. The list is built automatically and is only updated if the gas selected from Custom Gases or Library is not already in the Last Ten. This ensures that there is no repetition.
- **Gas Library** is a library that consists of more than 200 gases for the PID sensor and more than 50 for the catalytic LEL sensor.
- **Custom Gases** are gases with user-modified parameters. Using ProRAE Studio II, all parameters defining a gas can be modified, including the name, span value(s), correction factor, and default alarm limits.

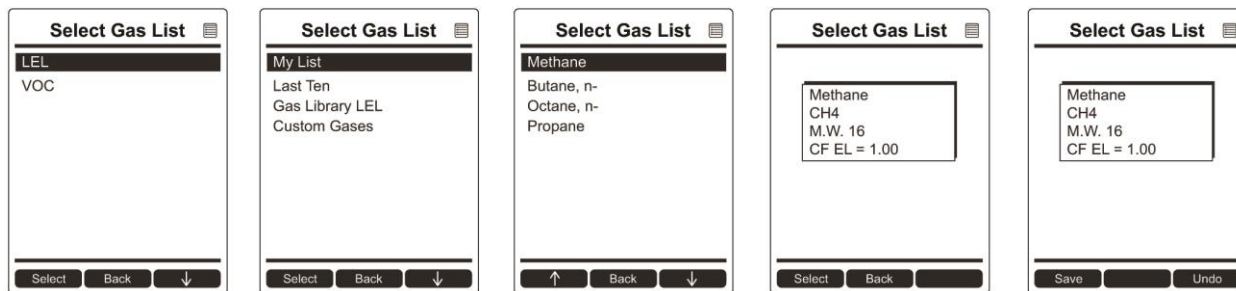

12.3.4.3. Measurement Unit

In some cases, the measurement unit for displaying data from sensors can be changed. The type of sensor is shown in the display, and if there is more than one sensor type (VOC, EC, Gamma), they are shown in a list.

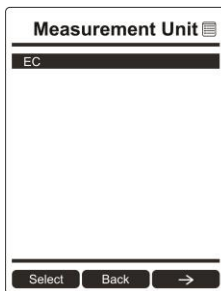

AreaRAE Plus & AreaRAE Pro User's Guide

Depending on the installed sensors, standard available measurement units include:

Abbreviation	Unit	Sensor Type
ppm,ppb	parts per million, parts per billion	PID for VOC
mg/m3, ug/m3	milligrams per cubic meter, micrograms per cubic meter	PID for VOC
ppm	parts per million	EC
mg/m3	milligrams per cubic meter	EC
µrem/h, mrem/h	microrems and millirems per hour	Gamma
µSv/h, mSv/h	microSieverts and milliSieverts per hour	Gamma
µR/h, mR/h	microRoentgens and milliRoentgens per hour	Gamma
µGy/h, mGy/h	microGrays and milliGrays per hour	Gamma
ppm	parts per million	CO ₂
VOL	Volume	CO ₂
° F	Fahrenheit degrees	Temperature
° C	Celsius degrees	Temperature
m/s	meter per second	Wind speed
MPH	mile per hour	Wind speed

Here is an example of the menu hierarchy (select the sensor type and then the measurement unit):

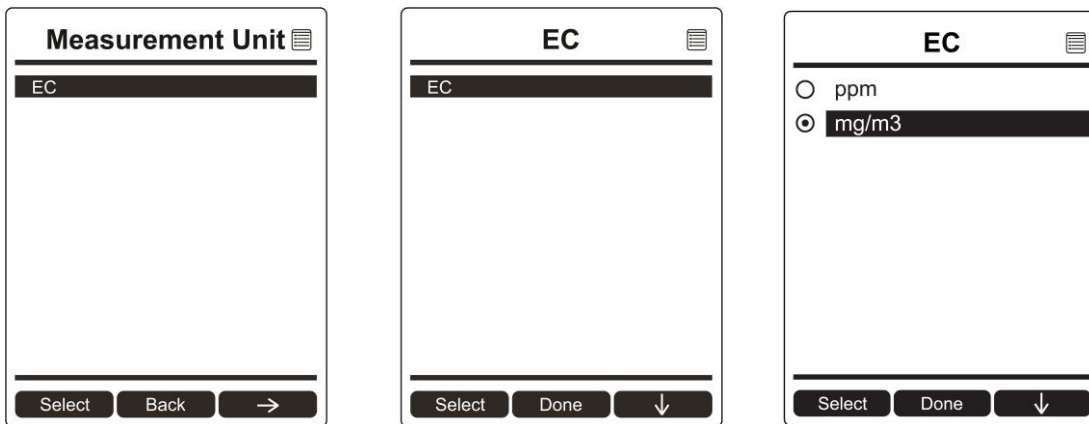

AreaRAE Plus & AreaRAE Pro User's Guide

12.3.5 Alarms

Use this menu to change high, low, STEL, and TWA alarm limits - the points at which alarms are triggered. The Alarms menu also allows changing alarm mode (latched or automatic reset) and alarm output methods (combinations of light and buzzer alarm indications).

12.3.5.1. Alarm Limits

There are four groups of alarm settings that you can adjust for each individual sensor for which a particular alarm type is available.

Settings:

- High Alarm
- Low Alarm
- STEL (Short-Term Exposure Limit) Alarm
- TWA (Time-Weighted Average) Alarm

Note: Some alarm settings are not applicable to all sensors. If a setting is irrelevant to a sensor (for example, STEL for a gamma radiation sensor), then that sensor does not appear in the list.

12.3.5.2. Alarm Mode

You can program the AreaRAE Plus/Pro so that there are two ways to shut off an alarm:

Auto Reset	When the alarm condition is no longer present, the alarm stops automatically.
Latch	You must manually turn off an alarm when one is triggered. The latched setting only controls alarms for High Alarm, Low Alarm, STEL Alarm, and TWA Alarm.

12.3.5.3. Alarm Settings

You can enable/disable any combination of light (visible) or buzzer (audible) alarms, or alarms off.

Settings:

- All Enabled
- Light
- Buzzer
- All Disabled

12.3.5.4. Comfort Beep

A Comfort Beep is a single beep of the audible alarm at 60-second intervals that informs the person using the AreaRAE Plus/Pro that it is functioning. It can be turned on or off.

AreaRAE Plus & AreaRAE Pro User's Guide

12.3.6 Datalog

The instrument displays a floppy disk icon to indicate that a datalog is being recorded. The instrument stores the measured gas concentration for each sensor, date and time for each measurement, Site ID, User ID, and other parameters. The AreaRAE Plus/Pro memory is sufficient to record six months' worth of data for 12 sensors and GPS at one-minute intervals, 24/7. All data are retained (even after the unit is turned off) in non-volatile memory so that they can be downloaded at a later time to a PC.

12.3.6.1. Clear Datalog

This operation erases all data stored in the datalog. Select "Clear Datalog," and then "Yes."



Note: Once the datalog is cleared, the data cannot be recovered.

12.3.6.2. Datalog Interval

Intervals are shown in seconds. The default value is 60 seconds. The maximum interval is 3600 seconds, and the minimum is 1 second.

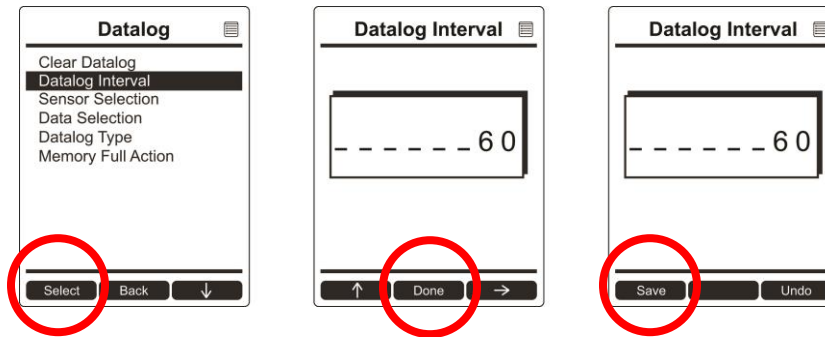

12.3.6.3. Sensor Selection

You can choose which sensors' data are included in the datalog. The entire list of installed sensors is shown, and you can individually select whether their data is included.

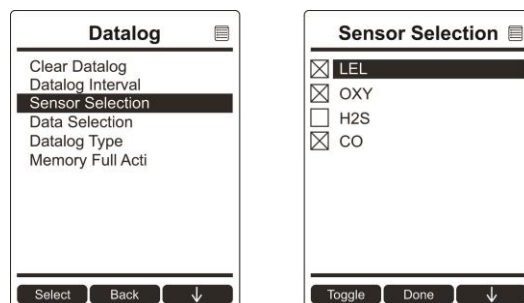

AreaRAE Plus & AreaRAE Pro User's Guide

Note: Turning a sensor off in the list does not change or erase its settings.

12.3.6.4. Data Selection

Data Selection allows you to select which types of data are stored and made available when you download your datalog to a computer via ProRAE Studio II (version 1.04 or higher) software.

You can choose any or all of four types of data (you must choose at least one):

- Minimum
- Average
- Maximum
- Real-Time

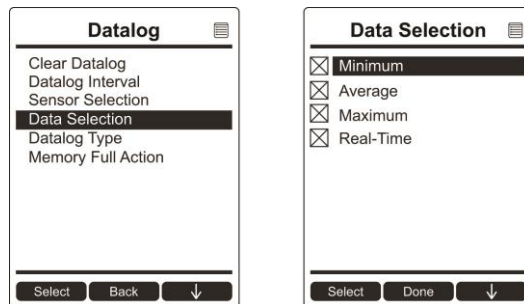

12.3.6.5. Datalog Type

The instrument offers three options for starting the datalogging process:

- Auto** Automatically collects datalog information every time the instrument is sampling until the datalog memory is full.
- Manual** Datalogging occurs only when you manually initiate it (see below for details).

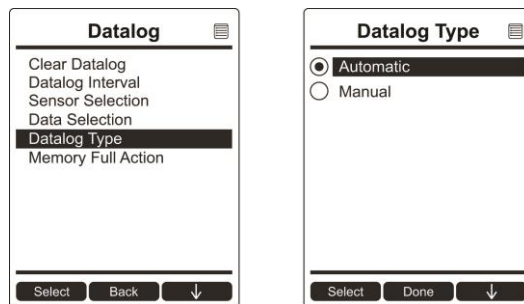

Note: You can only choose one datalog type to be active at a time.

About Manual Datalogging

When the instrument is set to Manual Datalog, you can turn datalogging on and off by repeatedly pressing [N/-] and stepping through the screens from the main display until you reach the screen that says “Start Datalog?”

- When you reach the screen that says “Start Datalog?” press [Y/+] to start it. You see “Datalog Started,” confirming that datalogging is now on. You can turn it off by pressing [Y/+] again.
- If datalogging is running, you can leave it running. However, if you want to turn it off, follow this procedure:

AreaRAE Plus & AreaRAE Pro User's Guide

Press [N/-] repeatedly to step through the screens until you reach the screen that says, “Stop Datalog?” Press [Y/+] to stop datalogging. The screen displays “Datalog Stopped” for a few seconds, before displaying “Start Datalog?” and the datalog interval. You can restart it anytime by pressing [Y/+] from that screen.

12.3.6.6. Memory Full Action

When the internal datalog memory is full, the AreaRAE Plus/Pro can either stop collecting data (Stop When Full) or go back to the beginning and overwrite the data from the first entry, second entry, etc. (Wraparound).

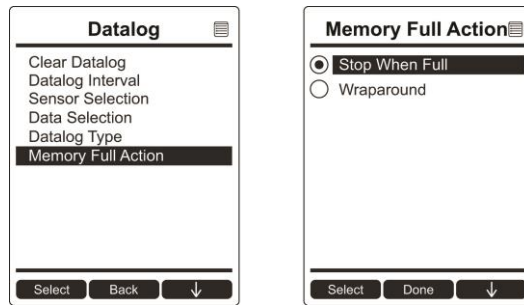

AreaRAE Plus & AreaRAE Pro User's Guide

12.3.7 Wireless

When an AreaRAE Plus/Pro is equipped with a wireless modem, its settings are controlled via the menu items under “Wireless.”

Note: Instruments equipped with Wi-Fi provide different menu choices. Refer to page 37 for details.

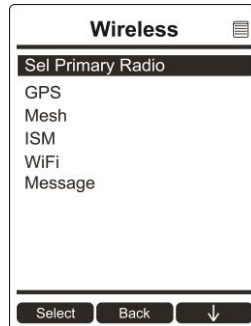

12.3.7.1. Select Primary Radio

Select the primary radio through ProRAE Studio II.

Note: Either ISM or Wi-Fi can be active, but not both at the same time.

If you select “ISM,” then “ISM” shows up in the menu list on the AreaRAE Plus/Pro’s screen under “Wireless.” If you select “WiFi,” then “WiFi” shows up in the menu list on the AreaRAE Plus/Pro’s screen under “Wireless.” The choice that is not selected to be active does not appear in the list.

12.3.7.2. GPS

GPS receivers operate by line of sight with global positioning satellites. A receiver must be able to get signals from at least four satellites in order to calculate longitude and latitude (there are currently 30 GPS satellites orbiting the earth). The more satellites a GPS receiver can “see,” the more accurate and reliable the positioning.

For a GPS-equipped AreaRAE Plus/Pro to work properly, it must have a direct line of sight to a satellite, meaning it will not work well (if at all) indoors. Although radio signals from navigation satellites can pass through clouds, glass, plastic and other lightweight materials, satellite navigation receivers do not work underground or in other enclosed spaces.

If you need to operate a monitor under a roof or anything else that obstructs a clear view of the sky, you may need to take the AreaRAE Plus/Pro outdoors into a nearby clear area, manually set GPS coordinates in ProRAE Guardian, and allow those coordinates to be used on maps in ProRAE Guardian running on a host computer.

You can turn the GPS power on or off.

1. Press [Y/+] to see on and off states, and which is selected.
2. Press [N/-] to scroll to “On” or “Off.”
3. Press [Y/+] to select.
4. Press [Y/+] to “Save.” You can also press [N/-] to undo.

AreaRAE Plus & AreaRAE Pro User's Guide

12.3.7.3. Mesh

The AreaRAE Plus/Pro's secondary Mesh radio is designed to work in a RAE Systems wireless mesh radio network. This type of flexible, robust wireless network provides reliable, low-cost operation and supports point-to-point and point-to-multi-point networking with ProRAE Guardian monitoring software.

Options include:

- Power On/Off
- PAN ID
- Channel
- Factory Reset

12.3.7.4. On/Off

1. Press [Y/+] to see on or off state, and which is selected.
2. Press [N/-] to scroll to "On" or "Off."
3. Press [Y/+] to select.
4. Press [Y/+] to "Save." You can also press [N/-] to undo.

12.3.7.5. PAN ID

The AreaRAE Plus/Pro and any other devices that you want to interconnect wirelessly must have the same PAN ID. You can set the PAN ID in the instrument or through ProRAE Studio II.

1. Press [Y/+] to increase the number and [N/-] to advance to the next digit.
2. After moving to the last digit and making changes, press [MODE].
 - Press [Y/+] to save the change.
 - Press [N/-] to undo the change.

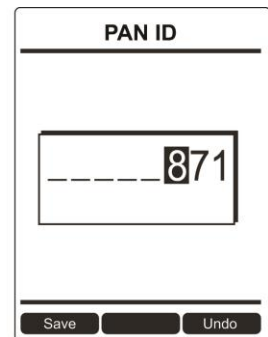
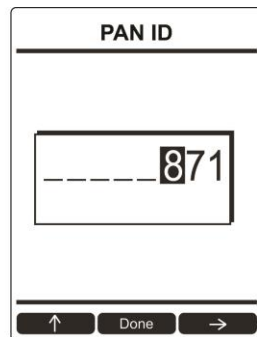
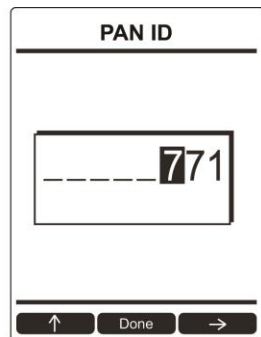
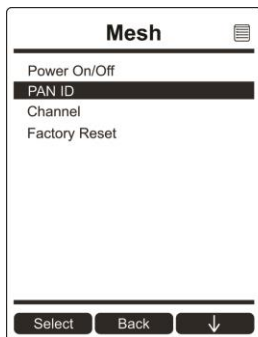

AreaRAE Plus & AreaRAE Pro User's Guide

12.3.7.6. Channel

The AreaRAE Plus/Pro and any other devices that you want to interconnect wirelessly must be operating on the same channel.

1. Press [N/-] to step through the channel numbers from 1 through 10.
2. Once your selection is highlighted:
 - Press [Y/+] to select the channel.
 - Press [Y/+] to save your choice or press [N/-] to undo your changes.

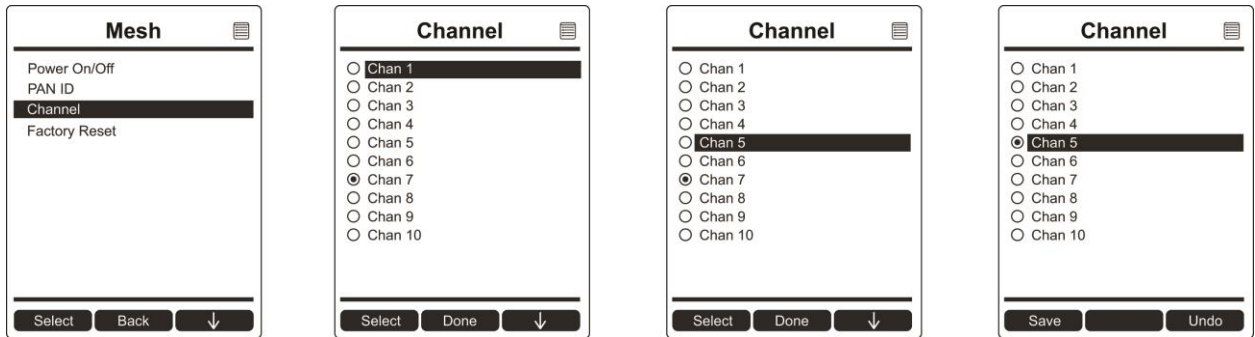

Note: You cannot change the channel setting on an instrument equipped with a radio modem that operates at a frequency of 868 MHz.

12.3.7.7. Factory Reset

Restore all the wireless settings to their original factory defaults.

Caution! Once you reset the wireless settings, you cannot retrieve any of the settings deleted by performing this reset.

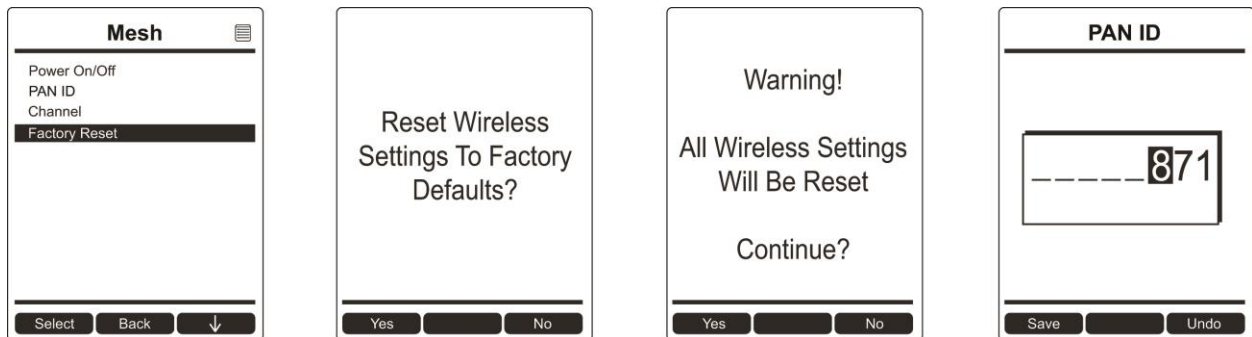

- Press [Y/+] to reset the wireless settings.
- Press [N/-] to exit without resetting the wireless settings.

AreaRAE Plus & AreaRAE Pro User's Guide

12.3.8 ISM

The AreaRAE Plus/Pro and any other devices that you want to interconnect wirelessly through ISM must have the same Network ID (1 to 4095, but do not use 255), as well as a unique Unit ID (1 through 64). You can set the Network ID in the instrument or through ProRAE Studio II.

1. Press [Y/+] to increase the number and [N/-] to advance to the next digit.
2. After moving to the last digit and making changes, press [MODE].
 - Press [Y/+] to save the change.
 - Press [N/-] to undo the change.

12.3.8.1. Power On/Off

You can turn the ISM radio's power on or off.

1. Press [Y/+] to see on or off state, and which is selected.
2. Press [N/-] to scroll to "On" or "Off."
3. Press [Y/+] to select.
4. Press [Y/+] to "Save." You can also press [N/-] to undo.

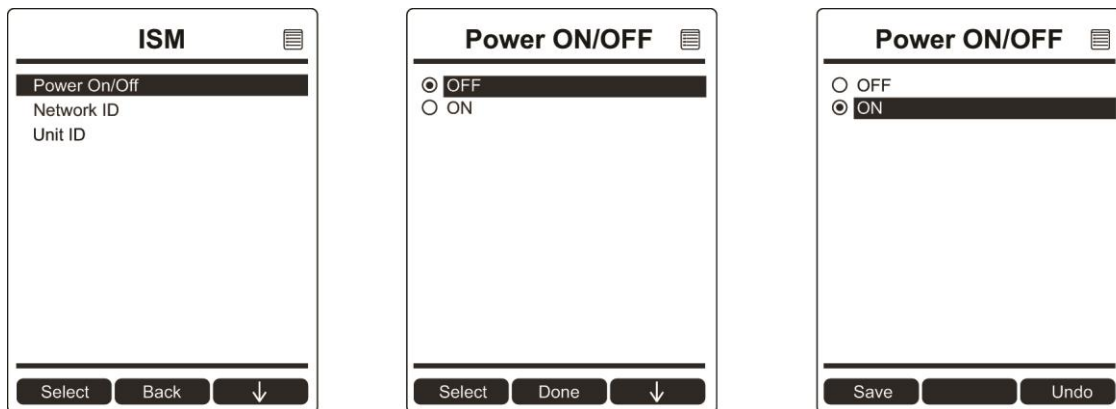

12.3.8.2. Network ID

Every ISM network must have a Network ID, which identifies that network and all equipment operating in that network. All instruments, including the host, repeaters, etc., in the same network need to be configured with the same Network ID.

1. Press [Y/+] to increase the number and [N/-] to advance to the next digit.
2. After moving to the last digit and making changes, press [MODE].
 - Press [Y/+] to save the change.
 - Press [N/-] to undo the change.

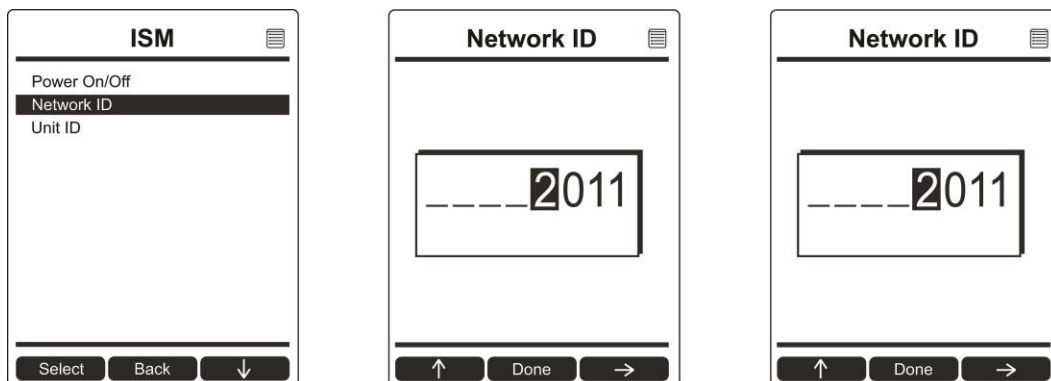

AreaRAE Plus & AreaRAE Pro User's Guide

12.3.8.3. Unit ID

Each instrument in an ISM network must be assigned a unique Unit ID (between 00 and 99). Make sure that the unit ID is not duplicated among any of the units within the same network.

1. Press [Y/+] to increase the number and [N/-] to advance to the next digit.
2. After moving to the last digit and making changes, press [MODE].
 - Press [Y/+] to save the change.
 - Press [N/-] to undo the change.

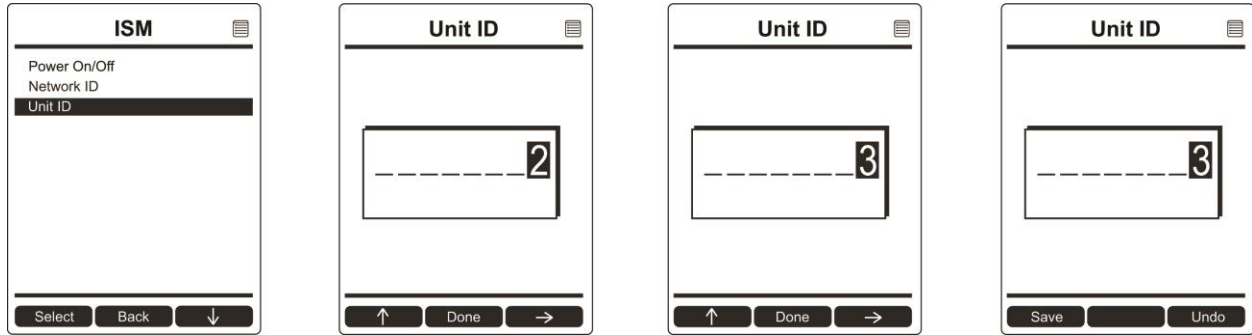

12.3.9 Wi-Fi

You can turn the Wi-Fi radio's power on or off.

1. Press [Y/+] to see on and off states, and which is selected.
2. Press [N/-] to scroll to "On" or "Off."
3. Press [Y/+] to select.
4. Press [Y/+] to "Save." You can also press [N/-] to undo.

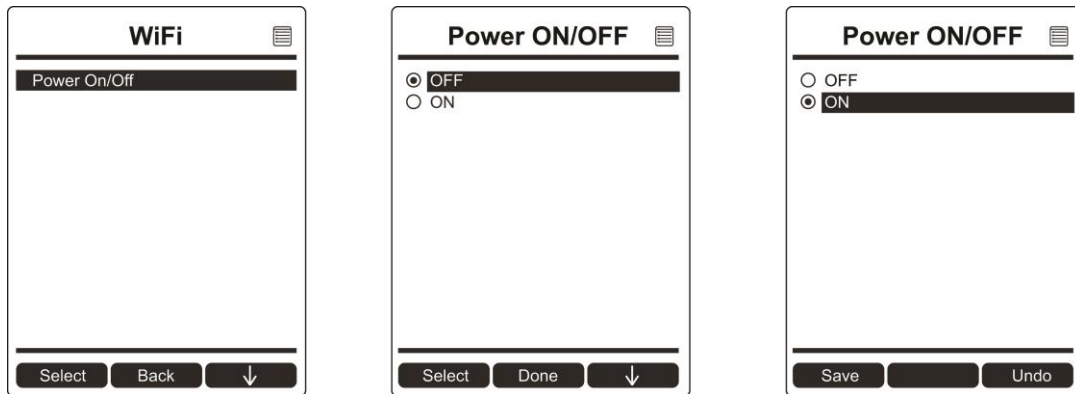

In order to communicate via Wi-Fi, you must configure Wi-Fi settings for the AreaRAE Plus/Pro to match your router by using ProRAE Studio II:

1. Connect a USB cable between the AreaRAE Plus/Pro and a PC running ProRAE Guardian.
2. In Normal mode, press the [N/-] key until the screen shows "Enter Communication Mode?"
3. Press [Y/+].
4. Start ProRAE Studio II on the PC.
5. Log in as Administrator. You must provide a password (the default is "rae".)
6. Click the "A" (for Automatic) detection.
7. When the AreaRAE Plus/Pro shows up in the list, click on it and then click "Select."
8. Click "Setup" when the list of items is shown on the left. This downloads the instrument's setup.
9. Click "Wi-Fi." This is where you see the current Wi-Fi parameters and can set new ones.

AreaRAE Plus & AreaRAE Pro User's Guide

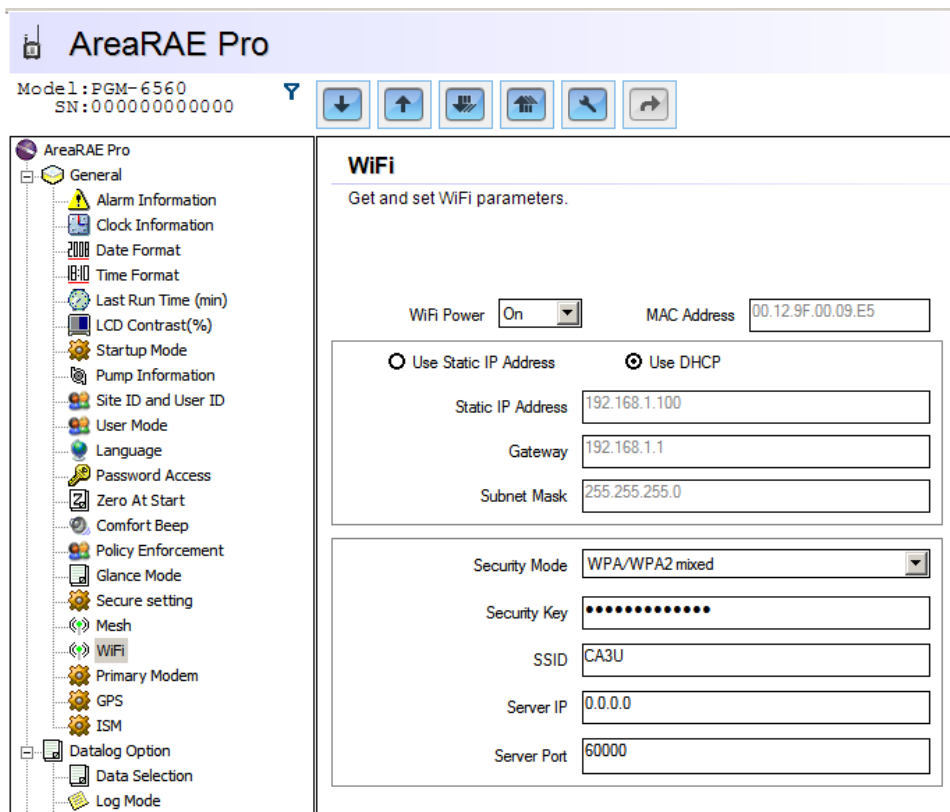

10. It is recommended that you select “Use DHCP” to dynamically set up the correct settings. If you must use a Static IP Address (many corporate enterprises require it), check with your I.T. administrator.

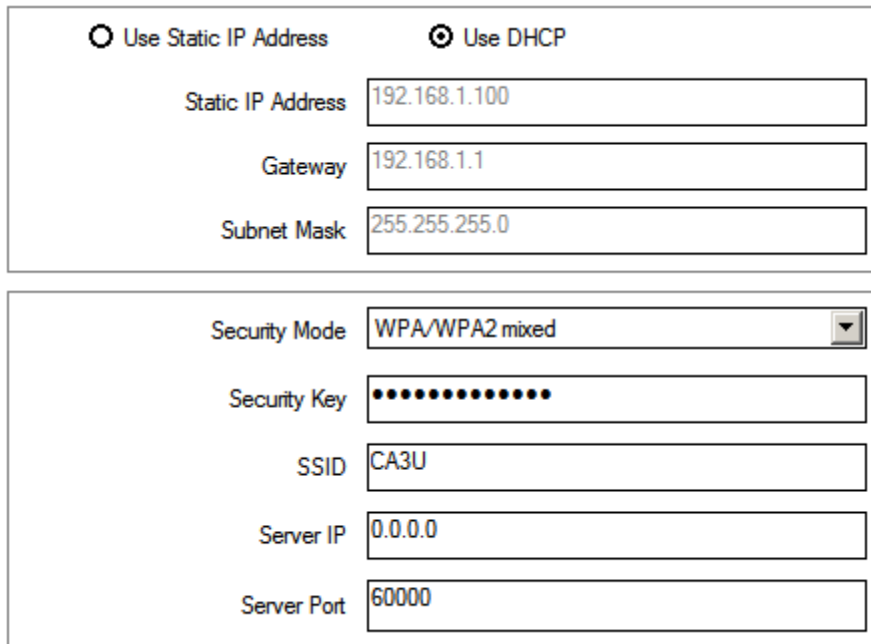

11. Settings for “Security Mode,” “Security Key,” and “SSID” must match the settings on the router associated with the PC or server running ProRAE Guardian.
12. Settings for “Server IP” and “Server Port” must match those of the PC or server running ProRAE Guardian.

AreaRAE Plus & AreaRAE Pro User's Guide

13. Once your settings are made, upload the settings to the AreaRAE Plus/Pro. Click this icon:



14. When uploading is finished, quit ProRAE Studio II.
15. On the AreaRAE Plus/Pro, press [Y/+] to exit Communication mode.
16. Disconnect the USB cable.

12.3.10 Message

When the instrument has received a message from ProRAE Guardian on the network, “Message” is shown in the Wireless menu on the AreaRAE Plus/Pro. If you scroll to “Message” and press [Y/+] to select it, a message screen is shown. If there are no messages, then the word “Message” is not shown in the menu.

12.3.11 Monitor

The submenus under “Monitor” control the following:

- LCD Contrast
- Zero At Start
- Fast Startup
- Language
- Site ID
- User ID
- Secure In Place

Press [N/-] to advance through the submenus, and when you reach the last one, it returns to the first selection.

12.3.11.1. LCD Contrast

The display's contrast can be increased or decreased from its default setting. You may not need to ever change the default setting, but sometimes you can optimize the display to suit extreme temperature and ambient brightness/darkness conditions.

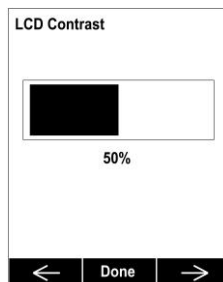

1. Use the [Y/+] and [N/-] keys to decrease or increase LCD contrast, respectively (the bar graph aids in setting it).
2. When you are done, press [MODE] to select “Done.”

If you have not made a change, it exits to the submenu's next selection. If you have made a change, you are prompted at the next screen to press [Y/+] to save the change or [N/-] to undo the change and exit to the next submenu selection.

AreaRAE Plus & AreaRAE Pro User's Guide

12.3.11.2. Zero At Start

If your AreaRAE Plus/Pro has been configured to perform a zero (fresh air) calibration upon startup, called Zero At Start, then the startup routine is interrupted so that you can perform a fresh air calibration for all sensors prior to using the instrument.

1. Press [Y/+] to see on or off state, and which is selected.
2. Press [N/-] to scroll to “On” or “Off.”
3. Press [Y/+] to select.
4. Press [Y/+] to “Save.” You can also press [N/-] to undo.

If you do not want to perform a zero calibration, press [MODE] to bypass it. If you start a zero calibration and want to abort it, press [N/-], and the calibration stops and the main display is shown.

12.3.11.3. Fast Startup

Fast Startup reduces the amount of time between when the instrument is turned on and is ready for use. It skips showing you many settings and is best suited to environments where the AreaRAE Plus/Pro is turned on and off very often during a given day. If Fast Startup is not selected, then when the instrument starts, it shows you details of each sensor, including calibration information, high and low alarm settings, etc.

1. Press [Y/+] to see on or off state, and which is selected.
2. Press [N/-] to scroll to “On” or “Off.”
3. Press [Y/+] to select.
4. Press [Y/+] to “Save.” You can also press [N/-] to undo.

12.3.11.4. Language

English is the default language, but other languages can also be selected for the instrument. **Note:** The language can also be changed through ProRAE Studio II.

1. Press [Y/+] to see the current, selected language.
2. Press [N/-] to scroll to the language you want.
3. Press [Y/+] to select.
4. Press [Y/+] to “Save.” You can also press [N/-] to undo.

12.3.11.5. Site ID

Choose and enter an 8-digit Site ID to uniquely identify the particular site where the instrument is to be used. The first four digits can be an alphabet letter or number, while the last four digits can only be numbers. This Site ID is included in the datalog report.

Note: Advance through the alphabet and numbers (0 through 9) by one with each press of the [Y/+] key. To scroll quickly, hold down the [Y/+] key for as long as you want it to scroll rapidly.

12.3.11.6. User ID

Enter an 8-digit alphanumeric User ID to uniquely identify a user. This User ID is included in the datalog report. The first four characters of a customized User ID act as an identifier for monitoring the instrument.

Note: Advance through the alphabet and numbers (0 through 9) by one with each press of the [Y/+] key. To scroll quickly, hold down the [Y/+] key for as long as you want it to scroll rapidly.

AreaRAE Plus & AreaRAE Pro User's Guide

12.3.11.7. Secure In Place

Secure In Place provides anti-tampering features to prevent unwanted access to screens or functions. These features use passwords to control access.

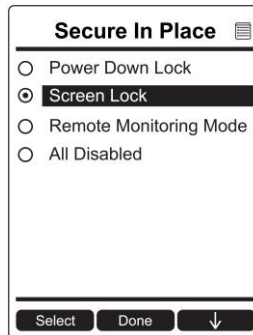

Power Down Lock: Requires that you enter the system password to power down the AreaRAE Plus/Pro. When Power Down Lock is selected, every time you want to shut down the AreaRAE Plus/Pro, you must hold the [MODE] button for five seconds and then at the prompt input the password.

Note: This feature is disabled by default, and is configurable via ProRAE Studio II and via the AreaRAE Plus/Pro's menu.

Screen Lock: AreaRAE Plus/Pro's Screen Lock mode prevents changing the screen from the main reading display without first entering a password. When Screen Lock is active, only the instantaneous reading screen is displayed.

Note: When screen lock is active, the alarm test function is not available by pressing the [Y/+] key, and the alarm test soft key is not displayed.

Remote Monitoring Mode: When AreaRAE Plus/Pro is programmed in Remote Monitoring mode, the screen displays the text "Monitor Active," indicating that the instrument is actively monitoring. During alarm events, the display reverts to Screen Lock mode. Once the alarm conditions are cleared, Remote Monitoring mode resumes.

Note: If enabled, Remote Monitoring mode is active upon entry to Normal mode, immediately after startup, and/or upon exiting Programming mode.

To select a Secure In Place feature (or to disable all of them):

1. Press [Y/+] to see the currently selected mode.
2. Press [N/-] to scroll to the mode you want.
3. Press [Y/+] to select.
4. Press [Y/+] to "Save." You can also press [N/-] to undo.

Your options are:

- Power Down Lock
- Screen Lock
- Remote Monitoring Mode
- All Disabled

AreaRAE Plus & AreaRAE Pro User's Guide

Accessing AreaRAE Set To Secure In Place When The Password Is Lost

If the instrument is locked via Secure In Place and you lose the password, it is possible to recover access to the AreaRAE. This requires that the Firmware version in the AreaRAE is v1.06 or higher. Also, you must connect the AreaRAE to a PC running ProRAE Studio II.

1. Use a USB cable to connect the AreaRAE to the PC running ProRAE Studio II.
2. Press [N/-] to enter the “Exit Screen Lock” screen:

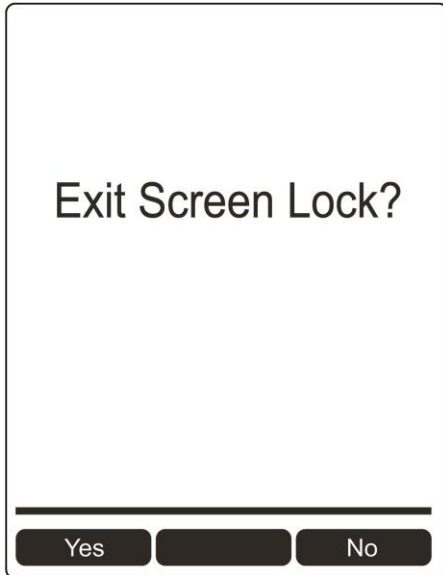

3. Press [Y/+] to enter the “Password” screen:

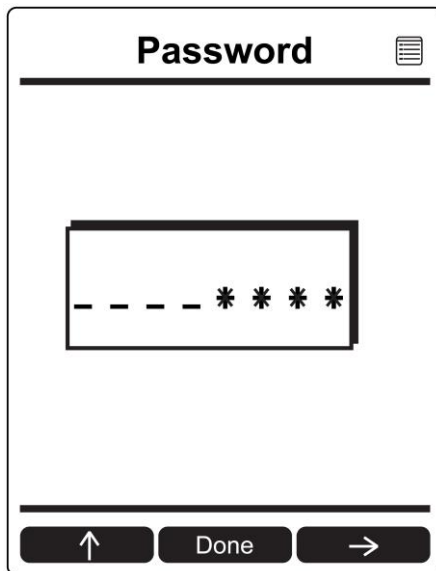

The AreaRAE can communicate with ProRAE Studio II. At this point, you can change the password or Secure In Place setting in ProRAE Studio II.

4. Start ProRAE Studio II.
5. Click “Setup” to download the settings.
6. Click “Password Access” to view and/or change the password. Or, click “Secure In Place” to change the Secure In Place setting.

AreaRAE Plus & AreaRAE Pro User's Guide

Note: The password screen only remains viewable for one minute. After that minute, AreaRAE 2 returns to the locked main reading page. Therefore, make changes quickly. If the screen returns to the locked page, repeat the process, beginning with step 2.

7. Upload the change to the AreaRAE.

13 User Modes

The AreaRAE Plus/Pro can be configured for two user modes, Basic and Advanced. The choice is selected and set in ProRAE Studio II.

13.1 Basic User Mode

In Basic User Mode, some restrictions are applied, including password protection that guards against entering Programming Mode by unauthorized personnel.

13.2 Advanced User Mode

In Advanced User Mode, there are no access restrictions (you do not need a password), and the AreaRAE Plus/Pro provides the indications and data you need most for typical monitoring applications.

14 Policy Enforcement

The AreaRAE Plus/Pro can be configured to enforce a facility/company's requirements that calibration and/or bump testing be performed at specified intervals, and to explicitly prompt the user that calibration/bump testing is required. Depending on how Policy Enforcement features are configured, the user may be required to perform a bump test or calibration prior to being able to use the instrument. That is, it can be set to not allow normal operation of the instrument unless calibration or bump testing is performed.

If the instrument has been bump tested and calibrated in compliance with the policy settings, a check-mark icon is included along the top of the AreaRAE Plus/Pro screen:



If Policy Enforcement is enabled, then after startup the AreaRAE Plus/Pro displays a screen that informs the user that the instrument requires either a bump test or a calibration. If both are required, then they are shown in sequence.

Note: Policy enforcement features are disabled by default.

14.1 Setting Policy Enforcement

You must use ProRAE Studio II to make changes to Policy Enforcement settings. The procedure requires connecting the AreaRAE Plus/Pro via USB cable to a PC running ProRAE Studio II. Policy violations are captured in the datalog.

1. Connect a USB cable between the AreaRAE Plus/Pro and a PC with ProRAE Studio II.
2. Put the AreaRAE Plus/Pro into PC Communications Mode.
3. Start ProRAE Studio II software on the PC.
4. Select "Administrator" and input the password (the default is "rae").
5. Click "Detect the instruments automatically" (the magnifying glass icon with the letter "A" in it). After a few seconds, the AreaRAE Plus/Pro is found and it is shown, along with its serial number:
6. Click on the icon to highlight it, and then click "Select."
7. Click "Setup."

AreaRAE Plus & AreaRAE Pro User's Guide

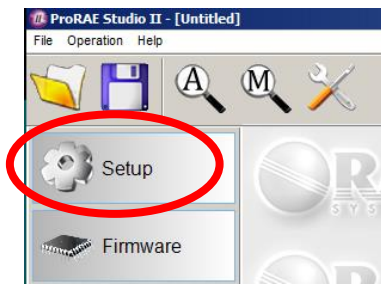

8. In the menu that now appears on the left side, click “Policy Enforcement.” It is highlighted, and the Policy Enforcement pane is shown:

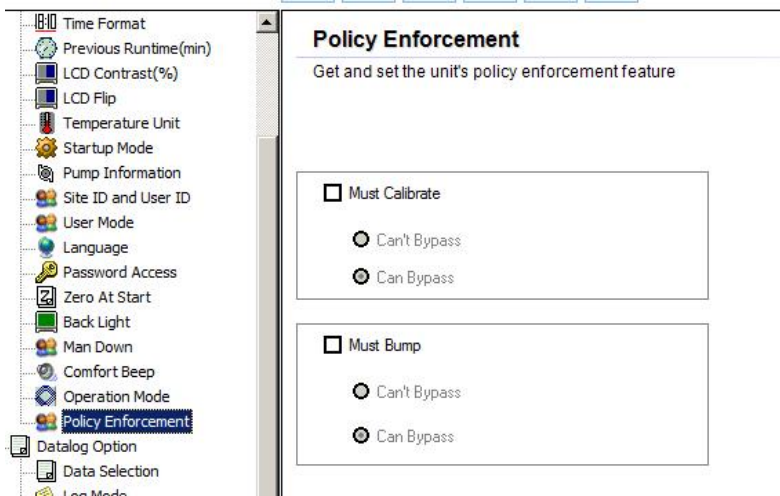

For “Must Calibrate” and “Must Bump,” you have the options of no enforcement or enforcement (including “Can’t Bypass,” and “Can Bypass”).

Must Calibrate. The user is prompted to calibrate the instrument when calibration is due (as set by the calibration interval). There are two programmable options:

- **Can’t Bypass.** Unless calibration is performed, the instrument cannot be used, and the only option is to turn off the instrument.
- **Can Bypass.** If calibration is due but the user does not want to perform a calibration, the instrument can still be used. In this case, the instrument records that the user has bypassed the calibration requirement in a Policy Violation report.

Must Bump. The user is prompted to bump test the instrument when a bump test is due (as set by the bump test interval). There are two programmable options:

- **Can’t Bypass.** Unless a bump test is performed, the instrument cannot be used, and the only option is to turn off the instrument.
- **Can Bypass.** If a bump test is due but the user does not want to perform one, the instrument can still be used. In this case, the instrument records that the user has bypassed the bump testing requirement in a Policy Violation report.

AreaRAE Plus & AreaRAE Pro User's Guide

These are the screens that are shown on an AreaRAE Plus/Pro after startup if “Can Bypass” is selected:

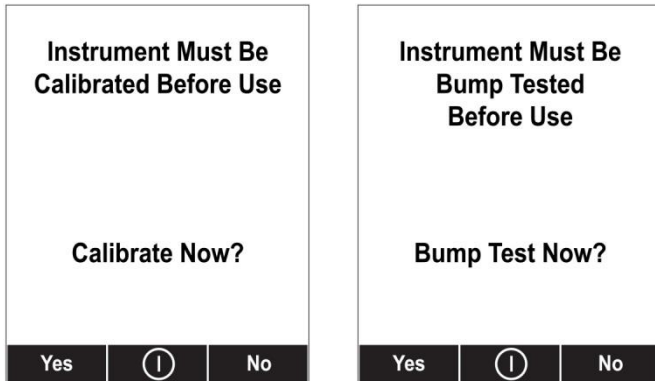

If “Can’t Bypass” is selected, the display looks like this, and only allows the options of performing the test or shutting down:

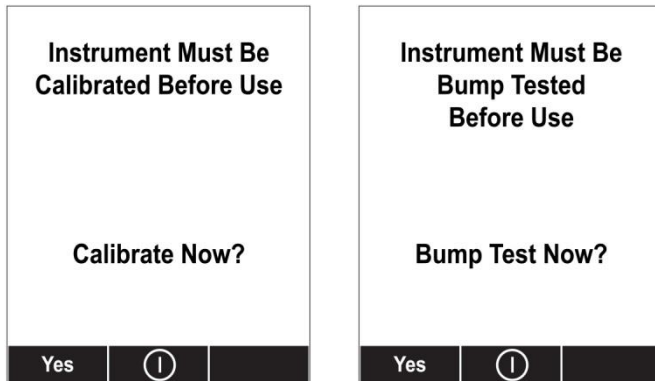

16. Once you have made your selections in ProRAE Studio II, you must upload the changes to the instrument. Click the icon labeled “Upload all settings to the instrument.”
17. A confirmation screen is shown. Click “Yes” to perform the upload, or “No” to abort. Uploading takes a few seconds, and a progress bar is shown. You can abort the upload by clicking “Cancel.”
18. Exit ProRAE Studio II.
19. Press [Y/+] on the AreaRAE Plus/Pro to exit Communication Mode.

14.2 Deactivating Policy Enforcement

If the AreaRAE Plus/Pro screen displays the message that it must be bump tested or calibrated, and if the option to bypass bump testing or calibration is not available, you should shut off the instrument and follow the procedure outlined here if you want to change the Policy Enforcement settings:

1. Use a USB cable to connect the AreaRAE to a computer running ProRAE Studio II.
2. Enter Diagnostic Mode on the AreaRAE Plus/Pro (with the instrument turned off, press and hold [Y/+] and [MODE] until it starts up).
3. After startup, enter the password when prompted (default is “0000”) and press [MODE].
4. Press [N/-] repeatedly until you see the “Enter Communications Mode?” screen.
5. Press [Y/+] to enter Communications Mode.
6. Start ProRAE Studio II.
7. Select “Administrator.”

AreaRAE Plus & AreaRAE Pro User's Guide

8. Input the password (the default is "rae").
9. Click "OK."
10. Click "A" (detect instruments automatically).
11. Click on the instrument's icon when it appears.
12. Click "Select."
13. Click "Setup."
14. Click "Policy Enforcement." The Policy Enforcement pane is shown.
15. Deselect Policy Enforcement features you do not wish to use.
16. Click "Upload all settings to the instrument."



17. When you see this confirmation. Click "Yes."

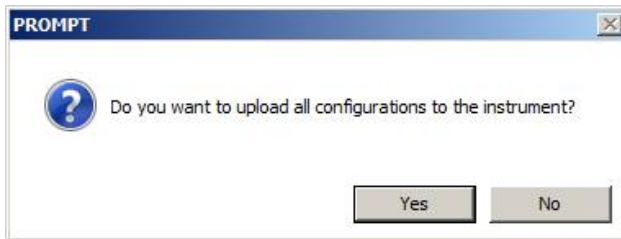

Uploading will take a few seconds, and this progress bar is shown:

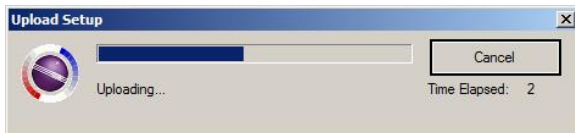

18. When the upload is done, exit ProRAE Studio II.
19. Press [Y/+] on the AreaRAE Plus/Pro to exit Communication Mode.

15 Calibration And Testing

15.1 Manual Alarms Test

Under Normal Operation Mode and non-alarm conditions, the buzzer (audible alarm), visible alarms, and backlight can all be tested anytime by pressing [Y/+] twice. If any alarm does not respond, check the alarm settings in the Programming Menu to make sure all alarms are enabled (selected setting under Programming/Alarms/Alarm Settings should be “All Enabled”). If any alarms are enabled but not functional, the instrument should not be used.

15.2 Bump Testing And Calibration

RAE Systems recommends that a bump test be conducted prior to each day's use. The purpose of a bump test is to ensure that the instrument's sensors respond to gas and all the alarms are enabled and functional.

- The AreaRAE Plus/Pro multi-gas detector must be calibrated if it does not pass a bump test when a new sensor is installed, after sensor maintenance has been performed, or at least once every 180 days, depending on use and sensor exposure to poisons and contaminants.
- Calibration and bump test intervals and procedures may vary due to national legislation and company policy.

During a bump test, the instrument makes a pass/fail decision based on sensor performance, but the user still has the responsibility to make sure all the alarms are enabled and functional.

15.2.1 Bump (Functional) Testing

A bump test can be performed on an individual sensor (Single Sensor Bump) or a group of sensors (Multi Sensor Bump) combined into Multi Cal. Select. The same gas is used for a bump test as for calibration. Typically, two cylinders of calibration gas are needed to perform a bump test or calibration on an instrument with a PID sensor and electrochemical and LEL sensors. This may require one gas cylinder with Isobutylene or another VOC test gas to test the PID sensor, and another with a 4-gas mix to test electrochemical (such as CO, H₂S, and O₂) and LEL sensors. As with calibration, the instrument intelligently splits the process into two consecutive steps: first, the wizard prompts for testing electrochemical and LEL sensors, and then it tests the PID sensor.

IMPORTANT!

Make sure all of the instrument's sensors have warmed up before performing a bump test. The instrument will take the time to warm up the sensors prior to enabling access to bump test menus. You can tell a sensor has warmed up if you see a reading next to its name on the display. If it has not warmed up, you see three dashes (“---”) next to it.

Teflon tubing must be used to test or calibrate the PID sensor. Follow the steps described here to perform a manual bump test:

1. Turn on your AreaRAE Plus/Pro by pressing and holding [MODE] (the middle button) and allow the instrument to boot up fully until the main measurement screen with sensor names and readings is shown.
2. Enter the Bump Test menu. It is accessible either through Programming Menu.

AreaRAE Plus & AreaRAE Pro User's Guide

3. Connect the AreaRAE Plus/Pro to the calibration gas. Turn on the gas to initiate flow.
4. Press [Y/+] to start the bump test. While the bump test is being performed, the readings for each sensor are shown. Once the bump test completes, pass/fail test results and readings are shown for each sensor.

Note: If a PID or other sensors are installed in the instrument require a dedicated cylinder of gas to calibrate, the instrument will prompt for calibrating such sensors at this point.

IMPORTANT!

If one or more sensors fails a bump test, be sure to calibrate those sensors.

5. The bump test is now complete. Press Exit to return to the main measurement screen.
6. Now perform a manual alarms test (see page 82).

If all the alarms and all sensors have passed and no sensor is due for a calibration, the instrument is now ready for use.

Note: When a manual bump test is performed, the readings shown are in the equivalent units of the calibration gas, and not the measurement gas (if different).

15.2.2 Bias & Equilibration For Liquid O₂ And Other Biased Sensors

Some electrochemical sensors (NO, NH₃, Liquid O₂) require a bias voltage to detect the gas, while most do not. Unbiased sensors may be shipped with a shorting pin across the electrodes to avoid an accidental bias. The pin should be removed before installation. Biased sensors require an equilibration time (also known as warm-up time) of at least 6 hours, and sometimes more, after installation for the baseline to become stable enough to calibrate the sensor. Unbiased sensors require at least 10 minutes to stabilize. Once installed, any sensor bias stays on, even when the meter is off. Therefore, even biased sensors are ready for immediate use when the instrument is turned on again, and the equilibration time is needed only when first installed or if the battery becomes completely drained. The SensorRAE 4R+ can be used to maintain bias on NO and other biased sensors, so long equilibration times can be avoided when installing such sensors into a multi-gas instrument.

CAUTION

If an instrument is calibrated directly after sensor installation (no equilibration time, no use of SensorRAE 4R+), readings will be seen to decrease until the sensor's bias is stable. Also, this may trigger a low alarm, even if calibration passes.

Refer to RAE Systems Technical Note TN-114 for a list of biased sensors.

AreaRAE Plus & AreaRAE Pro User's Guide

15.2.3 Testing The Gamma Radiation Sensor

The gamma radiation sensor does not require user calibration. To check whether the sensor is operational, place a gamma check-source on the upper half of the rear of the AreaRAE Plus/Pro equipped with a gamma sensor. The reading should increase.

15.2.4 Zero Calibration For Parts-Per-Billion (ppb) PID Sensor

IMPORTANT! The parts-per-billion PID sensor for volatile organic compounds (VOCs) should not be zeroed in fresh air. VOCs are normally present in ambient air, so zeroing the sensor in ambient air will not allow for a true zero to be set. The parts-per-billion PID sensor should be zeroed with ambient air using a charcoal filter or a VOC zeroing tube. Refer to the procedure on page 86.

15.2.5 Fresh Air Calibration

This procedure determines zero points of most sensors. The AreaRAE Plus/Pro should be zero-calibrated in clean air with 20.9% oxygen or with a cylinder of clean zero air.

Note: If you use a zero air cylinder, you must connect it directly to the filter that is attached to the instrument's inlet.

At the Calibration menu, select "Fresh Air" by pressing [Y/+] once to enter fresh air calibration.



After a timer countdown, the zero calibration is done. The LCD displays the sensor names and tells you whether each calibration passed or failed, followed by the sensor readings.

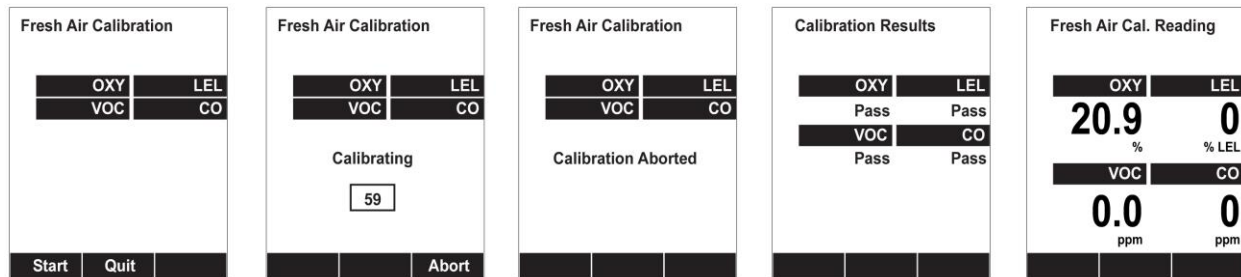

Note: You can abort the calibration at any time during the countdown by pressing [N/-].

AreaRAE Plus & AreaRAE Pro User's Guide

15.3 Span Calibration

This procedure determines the second point of the sensor calibration.

Note: When a manual calibration is performed, the readings shown are in the equivalent units of the calibration gas, and not the measurement gas.

15.4 Three-Point Calibration For Enhanced Linearity With Extended-Range And ppb PID Sensors

For better linearity at higher concentrations when an AreaRAE Plus/Pro is equipped with a PID sensor, a 3-point calibration can be performed.

IMPORTANT!

Three-point calibration is disabled by default, but can be enabled using ProRAE Studio II Instrument Configuration and Data Management software on AreaRAE Plus/Pro instruments with 10.6eV PID sensors, including high-range ppm and ppb PID sensors.

Default calibration gas settings for AreaRAE Plus/Pro PID sensors are as follows:

Sensor	Specifications	Zero	Span	Span 2 (Third calibration point, if enabled)
AreaRAE Plus/Pro parts-per-billion (ppb) PID	0 to 2,000 ppm range, 10 ppb resolution	With a charcoal filter or VOC zeroing tube	10 ppm Isobutylene	100 ppm Isobutylene
AreaRAE Plus/Pro extended-range ppm PID	0 to 5,000 ppm range, 0.1 ppm resolution	Fresh air or dry air	100 ppm Isobutylene	1,000 ppm Isobutylene
AreaRAE Plus/Pro 9.8eV PID	0.1 to 2,000 ppm; 0.1 ppm resolution	Fresh air or dry air	100 ppm Isobutylene 5 ppm Benzene	Not supported
4R+ 10.6eV (ppb) PID	0.1 to 2,000 ppm; 0.03 ppm resolution	With a charcoal filter or VOC zeroing tube	10 ppm Isobutylene	100 ppm Isobutylene
4R+ 10.6eV (ppm) PID	0.1 to 2,000 ppm; 0.1 ppm resolution	Fresh air or dry air	100 ppm Isobutylene	1,000 ppm Isobutylene

AreaRAE Plus & AreaRAE Pro User's Guide

15.4.1 VOC Zero Calibration Procedure For Enhanced Linearity With Extended-Range And ppb PID Sensors

You will need a VOC Zeroing Tube Adapter (P/N: 025-3002-000) and a VOC Zeroing Tube (P/N: W01-3011-000).

1. Inspect the external filter on the instrument and replace it if it appears to be dirty.
2. Break the two ends of a VOC Zeroing Tube by putting the ends into the small hole near the bottom of the tube box and snapping them off.

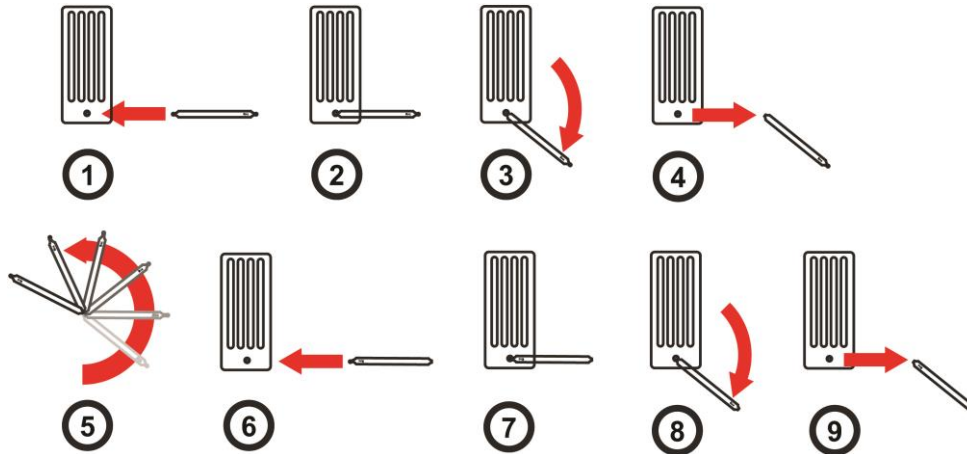

3. Connect the VOC Zero Tube Adapter to the external filter on AreaRAE Plus/Pro, and then insert one end of the VOC Zeroing Tube into the adapter. The arrow on the tube indicates the correct direction.

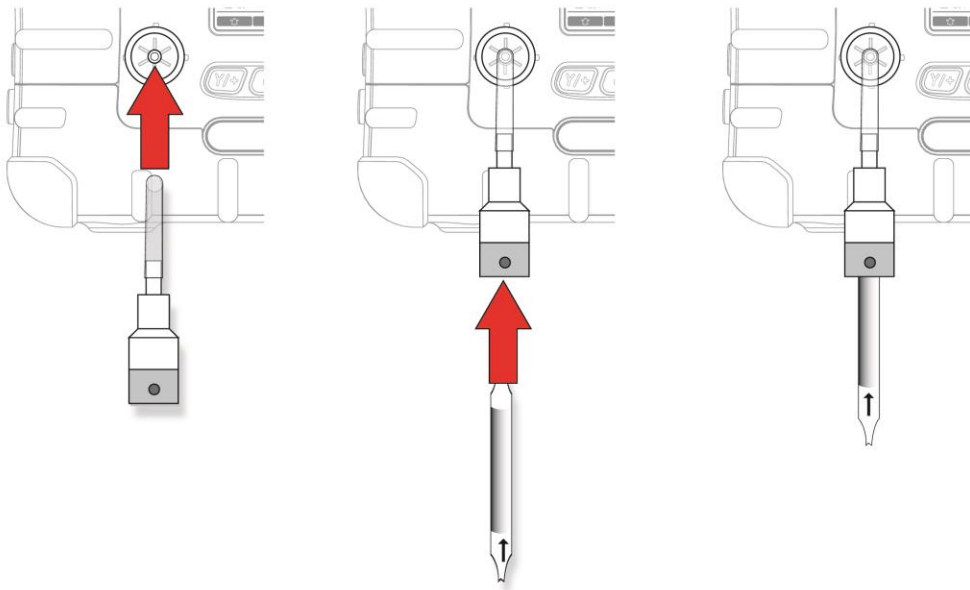

4. Run the zeroing calibration procedure for the instrument.
5. After zero calibration, properly dispose of the used VOC zeroing tube (it is designed for single use only), and remove the VOC Zeroing Adapter.

AreaRAE Plus & AreaRAE Pro User's Guide

15.4.2 Enabling 3-Point Calibration Via ProRAE Studio II

The AreaRAE Plus/Pro must be connected to a PC through the supplied USB cable and must be in the PC Communications mode.

1. Start up the ProRAE Studio II software, enter a password, and detect the instrument following the directions provided in the ProRAE Studio II User's Manual.
2. Click "Setup" to download the AreaRAE Plus/Pro's current configuration information
3. Click "Sensor Information."
4. Click the "+" to the left of "Sensor Summary" to show the list of installed sensors.
5. Click "VOC(ppm)" or "VOC(ppb)" to get and set sensor parameters.
6. Click 3-Point Calibration (the check mark should now be showing).
7. Click the "Upload all settings to the instrument" icon. You will be asked whether you want to upload all configurations to the instrument. Click "Yes."
8. When you are done, quit ProRAE Studio II and then press [Y/+] on the AreaRAE Plus/Pro to exit the PC communications mode. The instrument returns to operating in Normal mode.

15.4.3 Calibration Setup

For single-sensor and multi-sensor span calibration, there are three methods for calibrating. Each has different regulator type, flow rate, and pressure compensation requirements:

	Regulator Type	Flow Rate	T-Tube Necessary?
Good	Constant Flow	500 cc/min	No
Better	Constant Flow	750 cc/min	Yes
Best	Demand Flow	--	No

15.4.3.1. Using A T-Tube

Using Teflon tubing, attach one end of a "T" to the external filter on the AreaRAE Plus/Pro inlet. (You can use RAE Systems P/N: W01-3003-000).

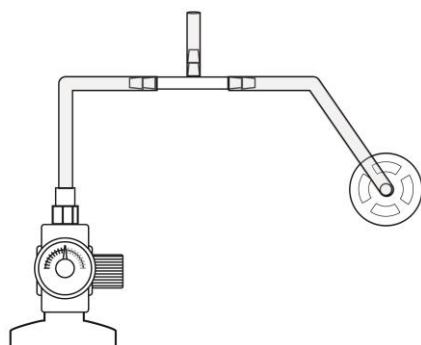

15.4.3.2. Calibrating Without A T-Tube

Use Teflon tubing to connect the calibration gas cylinder's regulator to the external filter on the AreaRAE Plus/Pro inlet.

AreaRAE Plus & AreaRAE Pro User's Guide

15.4.4 Multi-Sensor Span Calibration

This lets you perform a span calibration on multiple sensors simultaneously. It requires using the appropriate span gas and that the concentration labeled on the gas cylinder matches the concentration programmed in the AreaRAE Plus/Pro.

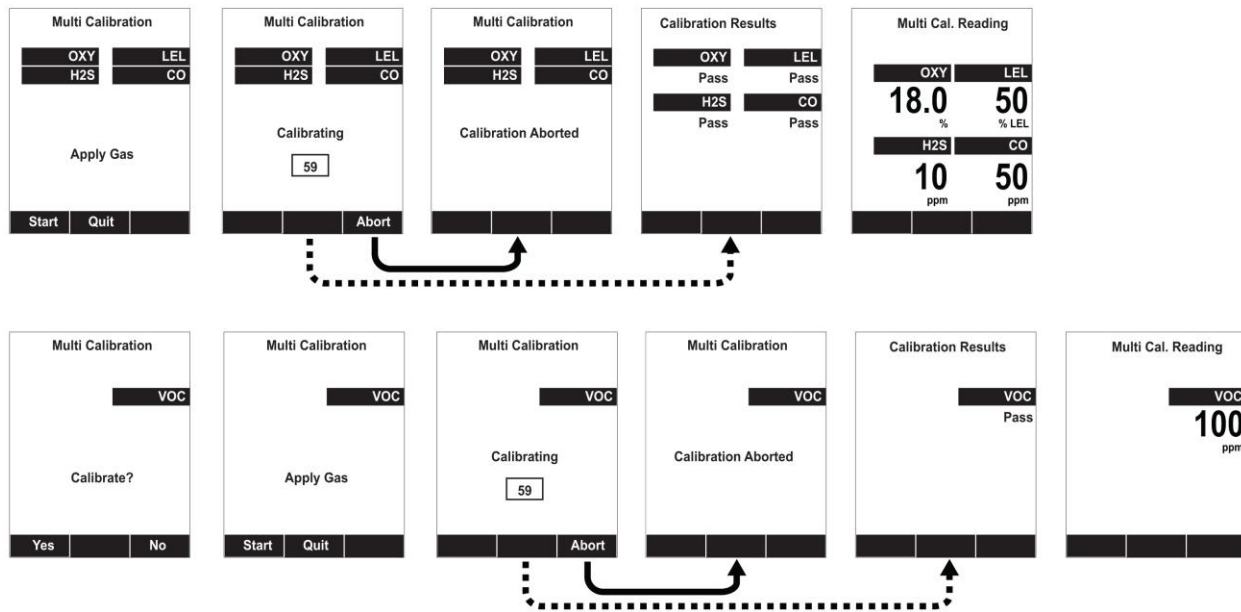

Teflon tubing must be used to test or calibrate the PID sensor. Follow the steps described here to perform a multi-sensor span calibration:

1. Attach the “T” tube and connect gas to the AreaRAE Plus/Pro.
2. Start the flow of gas and then either press [Y/+] to begin calibration or wait for calibration to start automatically once the sensor “senses” the gas. A countdown screen is shown. You can abort the calibration at any time during the countdown by pressing [N/-].

If the calibration reaches its conclusion, it shows the sensor names and tells you whether the calibration passed or failed, followed by the sensor readings.

Note: If there are other sensors to be calibrated at this stage, the screens will guide you through the process.

AreaRAE Plus & AreaRAE Pro User's Guide

15.4.5 Single-Sensor Span Calibration

To perform span calibration of an individual sensor, follow these steps:

1. At the Calibration Menu, select “Single Sensor Span.”
2. Select a sensor from the list.
3. Connect the “T” tube and connect it to a source of calibration gas.
4. Verify that the displayed calibration value meets the concentration label on the gas cylinder.
5. Start the flow of calibration gas.

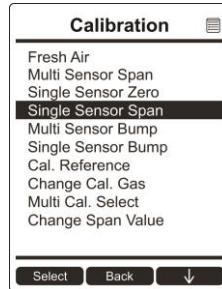

6. Press [Y/+] to start calibrating. You can abort the calibration at any time during the countdown by pressing [N/-].

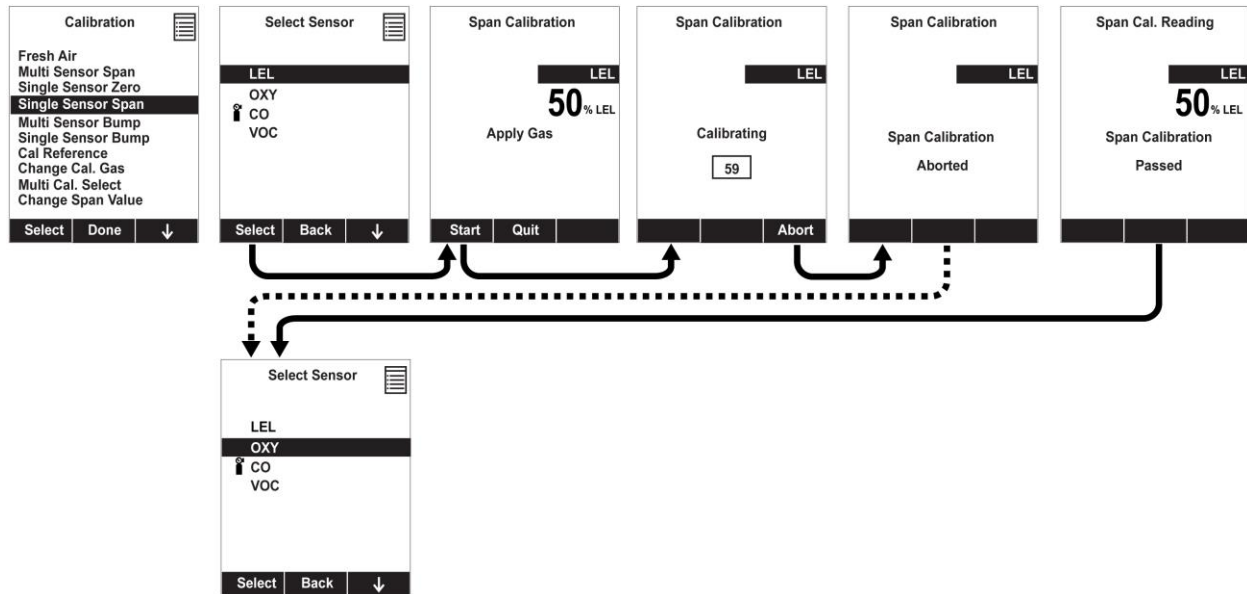

After a timer countdown, the span calibration is done. The LCD will display whether the calibration was successful and the reading for that calibration gas.

Note: If the sensor calibration fails, try again. If calibration fails repeatedly, turn off the instrument and then replace the sensor.

WARNING: Do not replace sensors in hazardous locations.

16 Datalog Transfer, Monitor Configuration, and Firmware Upgrades Via Computer

Datalogs can be downloaded from the AreaRAE Plus/Pro to a computer, and firmware updates can be uploaded to the AreaRAE Plus/Pro via the USB port on the side. Use the included USB cable to connect the AreaRAE Plus/Pro to a computer running ProRAE Studio II.

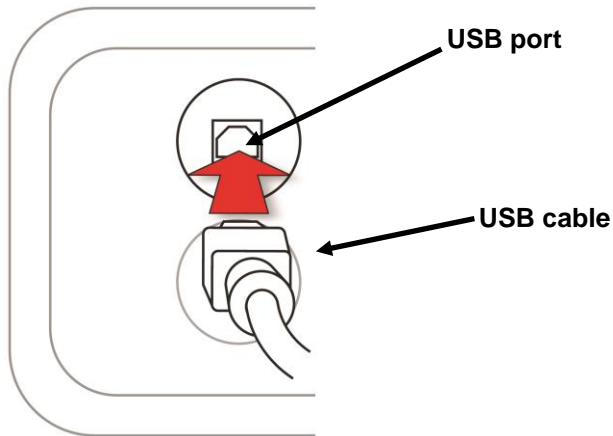

16.1 Downloading Datalogs And Performing PC-Based Instrument Configuration And Firmware Upgrades

The AreaRAE Plus/Pro communicates with a PC running ProRAE Studio II Instrument Configuration and Data Management software to download datalog, configure the instrument, or upgrade the instrument's firmware.

Note: The most recent version of ProRAE Studio II Instrument Configuration and Data Management software is available for a free-of-charge download at: <http://www.raesystems.com/downloads/product-software>.

1. Use the supplied PC Communications Cable to connect the AreaRAE Plus/Pro to a PC.
2. Turn on the AreaRAE Plus/Pro. Make sure it is running in Normal mode (with the main measurement screen showing).
3. Activate the PC communications mode on the AreaRAE Plus/Pro by pressing [N/-] repeatedly, starting from the main measurement screen until you reach the "Enter Communication Mode?" screen.
4. Press [Y/+]. Measurement and datalogging stop, and the instrument is now ready to communicate with the PC. The display now says "Ready To Communicate With Computer."
5. Start up the ProRAE Studio II software, enter a password, and detect the instrument following the directions provided in the ProRAE Studio II User's Guide.
6. Follow the instructions in the ProRAE Studio II User's Guide to download the datalog, configure the instrument settings, or update the AreaRAE Plus/Pro's firmware.
7. When you are done, press [Y/+] to exit the PC communications mode on the AreaRAE Plus/Pro. The instrument returns to operating in Normal mode.

IMPORTANT!

Always securely close the cover for the USB port when it is not in use. This keeps moisture and debris out of the port.

17 Maintenance

The AreaRAE Plus/Pro requires little maintenance, aside from replacing sensors, the filter, and the battery. The pump may need replacement, as well. If the instrument has a PID, then the PID sensor lamp and sensor electrode panel may require periodic cleaning.

17.1 Removing/Installing The Rubber Boot

In order to open the AreaRAE Plus/Pro, it is necessary to remove the belt clip and the rubber boot. Note that there are two hex screws on the bottom rear side that secure the boot.

1. Turn off the instrument.
2. Remove the external filter.
3. Remove the wind sensor (if one is attached).
4. Unscrew the two the two screws on each side.
5. Slide the top part of the boot upward until it clears the top of the instrument.
6. Slide off the bottom portion of the boot.

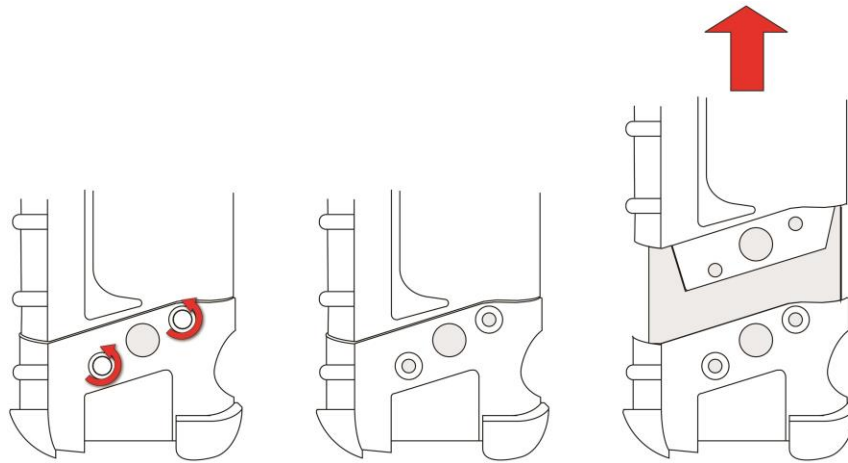

17.2 Replacing The External Filter

If a filter is dirty or clogged, remove it by unscrewing it from the black gas inlet adapter on the front of the instrument. Discard it and replace it with a new filter (P/N: 008-3022-000). Perform a pump stall test to make sure the inlet and the external filter are installed properly so that there are no leaks in the system.

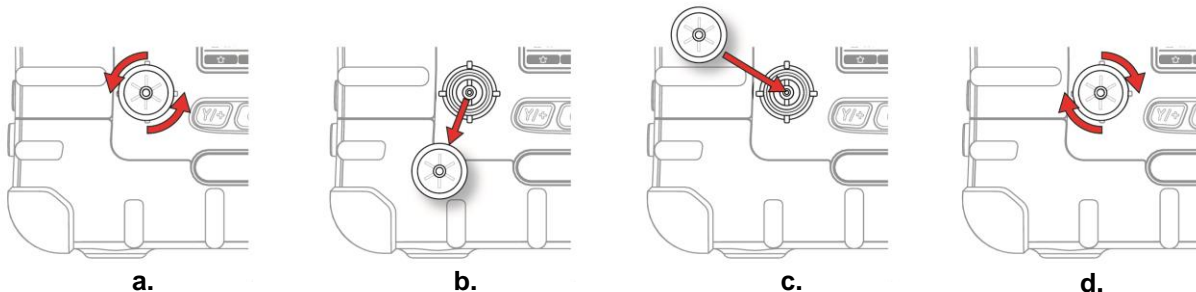

IMPORTANT!

An AreaRAE Plus/Pro must not be calibrated or operated without a filter. Operation without a filter may damage the instrument.

17.3 Removing/Cleaning/Replacing Sensor Modules

WARNING! Do not replace sensors in hazardous locations.

All sensors are located inside the sensor compartment in the upper half of the AreaRAE Plus/Pro. They are accessed by removing the cover that is held on by four screws.

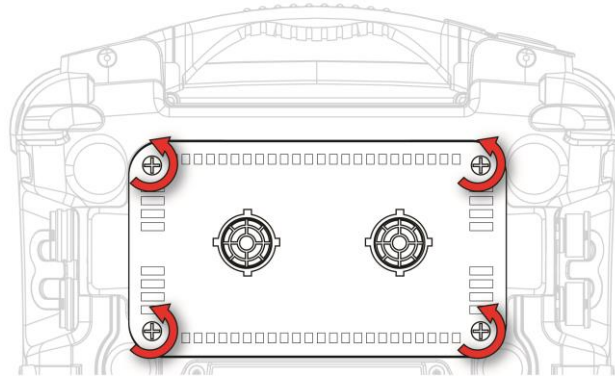

1. Turn off the instrument.
2. Remove the four screws holding the sensor compartment.
3. Remove the cover. The sensors are plugged into the slots.
4. Gently lift out the desired sensor module with your fingers.
5. Install the replacement sensor. It can only go into its slot one way. The connector inside the AreaRAE Plus/Pro and the indexing guides are good visual indicators of how to set the sensor into position. Make sure the indexing keys are aligned and press the sensor into place to ensure it is seated firmly. Note that the sensors are also in different sizes, and one size cannot be substituted for another.

Match index keys on sensor module with socket

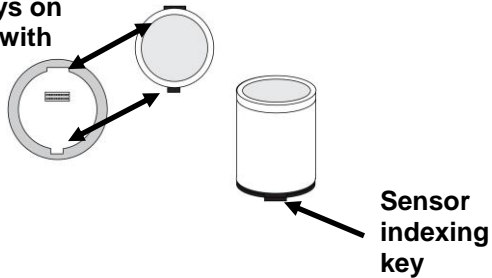

AreaRAE Plus & AreaRAE Pro User's Guide

17.3.1 Handling, Storage, And Calibration Of HF and HCL Sensors

1. Sensors must not be stored, assembled or installed in areas that contain solvent vapors. Especially at high concentrations, the organic solvents are known to cause:

- Blocking of the sensing electrodes
- Creation of false baselines
- In some cases, damaging of the electrodes
- Physical damage of the sensor body

A sensor must not be exposed to temperatures outside the range of -55°C to $+60^{\circ}\text{C}$ (-67°F to $+140^{\circ}\text{F}$).

2. It is recommended that sensors be stored in the originally sealed packaging at $+4^{\circ}\text{C}$ to $+10^{\circ}\text{C}$ (39°F to $+50^{\circ}\text{F}$), with the sensors' gas inlet side (membrane/filter side) pointing downwards.
3. Avoid storing the instrument for more than 12 hours in a way that sensors will be have their gas inlet side pointing upwards (equivalent to the instrument's screen pointing downwards).

HF & HCL Sensor Calibration

It is important to understand and acknowledge that HF and HCl sensors are not as easy to use and calibrate as any other EC (electrochemical) sensors, so we recommend strictly following the process described in RAE Systems Technical Note TN-201.

In addition, be aware that environmental conditions in end-users' applications, legal requirements, and the level of requested accuracy of the gas detection device towards the target gas determine the frequency of recalibration of the sensors.

AreaRAE Plus & AreaRAE Pro User's Guide

17.3.2 Sensor Locations

Location	Sensor type(s)
1	4R+ EC --- O ₂ (this is the preferred slot)
2	4R+ EC or 4R+ PID or 4R+ CO ₂ (For best results, do not use HF or HCl sensors in this slot.)
3	4R+ EC (avoid placing the O ₂ sensor in this slot)
4	4R+ EC
5	4R+ EC or LEL (For best results, do not use HF or HCl sensors in this slot.)
6	4R+ EC (avoid placing the O ₂ sensor in this slot)
7	7R+ sensors
8	7R+ sensors

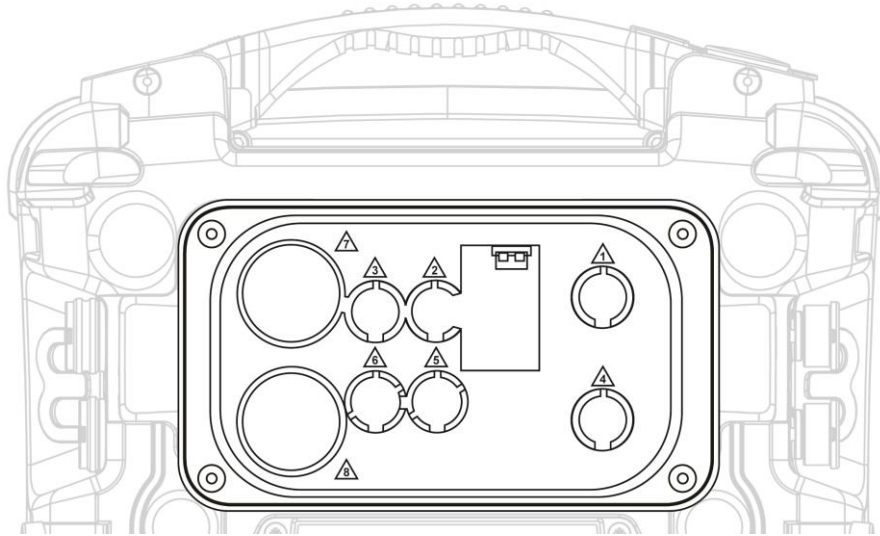

Note: The AreaRAE Plus/Pro does not allow duplicate sensors (that is, two or more of the same kind, including, for example, a 4R+ PID and a 7R+ PID) to operate simultaneously. Therefore, if duplicate sensors are inserted in the slots, when the instrument is turned on, it automatically senses the redundancy and only allows operation of one of the sensors, selecting the sensor in the location with the lowest number. The exception is the PID sensor: If both a 7R+ PID sensor and a 4R+ PID sensor are detected, then the 7R+ PID sensor is selected for operation.

WARNING!

If you are removing a sensor and not replacing it, its slot cannot be left empty. A “dummy” sensor must be installed in the empty slot.

17.4 Cleaning Or Replacing The PID

Note: The cleaning procedure is not normally needed. Clean the PID sensor module, the lamp and the lamp housing only when one of the following has happened:

1. The reading is inaccurate even after calibration.
2. The reading is very sensitive to air moisture.
3. A chemical liquid has been sucked into the unit and damaged the unit.

Use of the external filter helps to prevent contamination of the sensor.

AreaRAE Plus & AreaRAE Pro User's Guide

17.4.1 Cleaning Or Replacing The 4R+ PID

1. Gently lift out the PID module with your fingers.
2. If the module requires replacement (because the lamp does not illuminate, or the module has been used past its expiration date), place a new module into the slot, being careful to match the indexing keys. The sensor can only go into its slot one way. Refer to step 11 for alignment information.
3. If you want to open the sensor module to inspect and clean the lamp and sensor electrode panel, you must use the special tool (P/N: G02-0306-003). The special tool's "C"-shaped end has small "teeth" inside. Slide the tool so that the teeth slip into the notch between the module's cap and body:

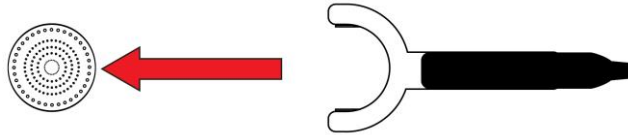

4. Gently pry up the cap using a rocking motion:

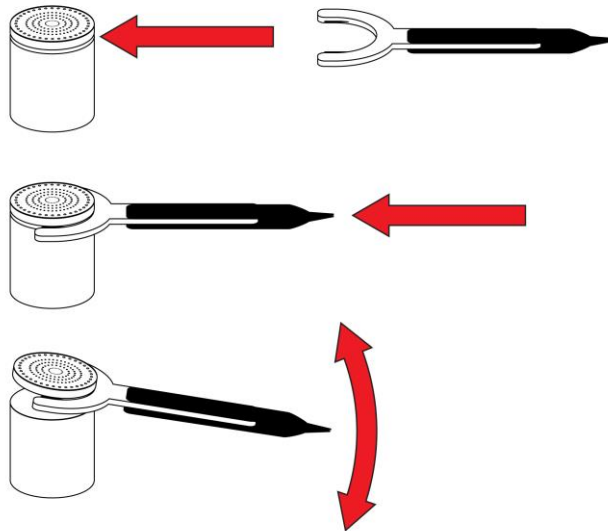

5. Once the cap is removed, set it aside.

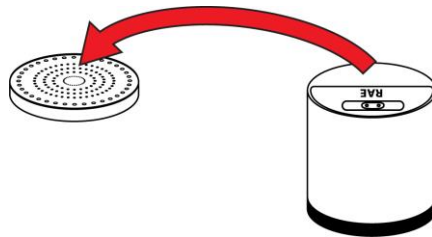

AreaRAE Plus & AreaRAE Pro User's Guide

6. Now lift the sensor electrode panel from the module:

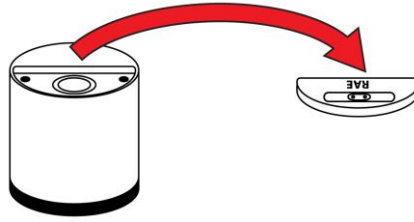

7. Clean the sensor electrode panel in a solution of isopropanol lamp cleaner (included, along with cleaning swabs, in a PID Lamp Cleaning Kit, part number 500-0014-010, package of 10), and allow it to dry.
8. Clean the lamp's window with a cleaning swab dipped in isopropanol lamp cleaner, and allow it to dry. Do not touch the lamp window with your fingers, as the residual oils will shorten its life.

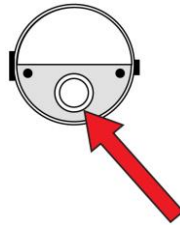

9. Inspect the electrical contacts. Clean them with a swab dipped in lamp cleaner if they appear to need cleaning (make sure the contacts are not pressed down when you are done):

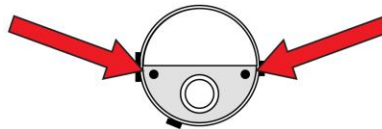

10. Reassemble the sensor module by placing the sensor electrode panel back in place and firmly pressing the cap back onto the top.

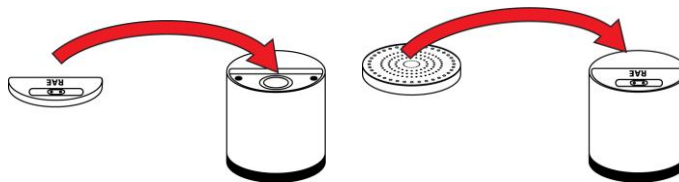

11. Place the sensor module back into the AreaRAE Plus/Pro. Make sure the index points are aligned (it can only go in one way).

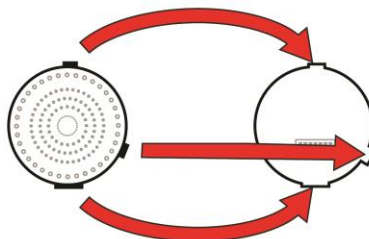

Match index points on sensor module with sensor slot

12. Carefully place the cap back onto the AreaRAE Plus/Pro and tighten the screw.

AreaRAE Plus & AreaRAE Pro User's Guide

17.4.2 Cleaning Or Replacing The 7R+ PID

Note: Always calibrate the AreaRAE Plus/Pro after replacing the sensor module.

1. Gently lift out the PID module from the instrument with your fingers.
2. If the module requires replacement (because the lamp does not illuminate, or the module has been used past its expiration date), place a new module into the slot, being careful to match the indexing keys. The sensor can only go into its slot one way.

If you want to open the sensor module to inspect and clean the lamp and sensor electrode panel, you must use the special 7R+ PID Sensor Cover Opening Tool (P/N: C04-2025-000).

1. Press the tool down around the sensor module, making sure to align the arrow on the module and the tool:

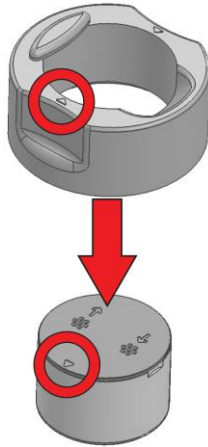

2. Check that the alignment of the two arrows is correct:



3. Locate the notch on the side of the sensor module.

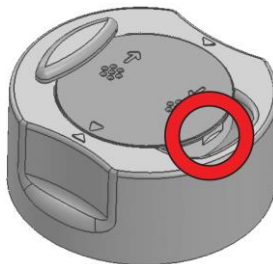

AreaRAE Plus & AreaRAE Pro User's Guide

4. Place the tip of a flat-blade screwdriver in the slot and gently pry up on the cover, using the tool for leverage.

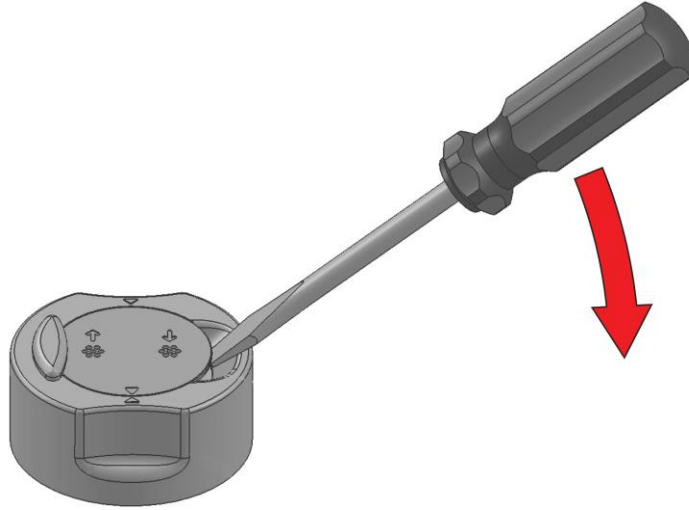

5. Once the cover is loose, remove the screwdriver.

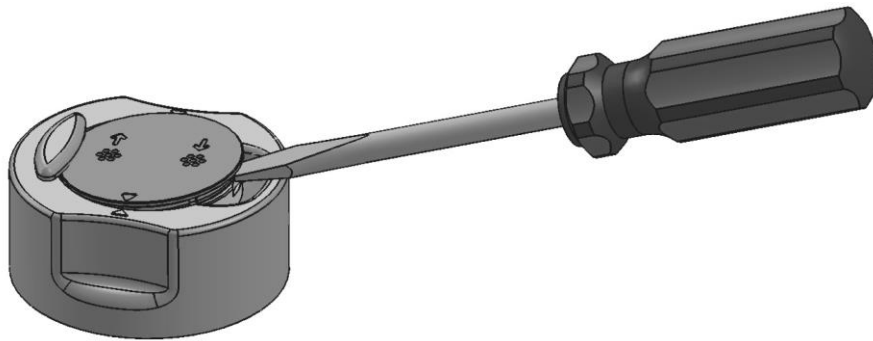

6. Lift the lid off, exposing the sensor electrode panel.

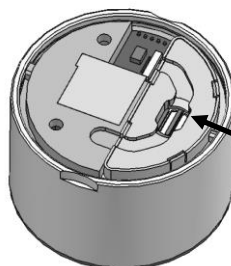
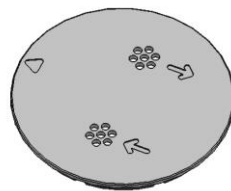

Sensor electrode panel

AreaRAE Plus & AreaRAE Pro User's Guide

7. Lift out the sensor electrode panel. The PID lamp's window is now visible.

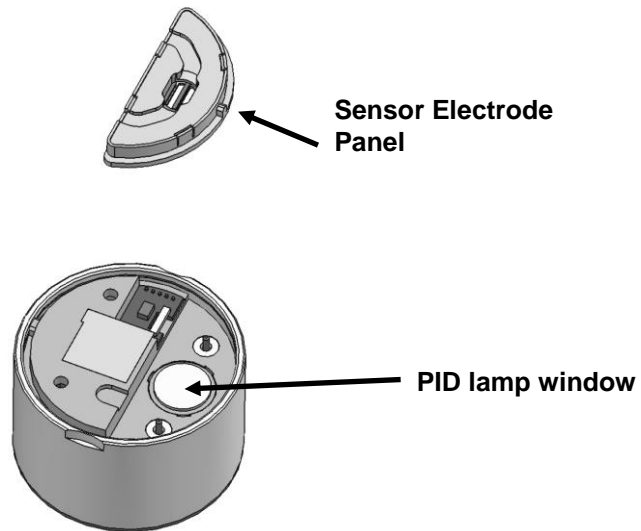

8. Use the 7R+ PID Lamp Removal Tool (P/N: C04-2026-000) to remove the lamp. With the tool's collar retracted (a), press down around the top of the lamp (b). Then press down the collar so that the tool grips the lamp (c).

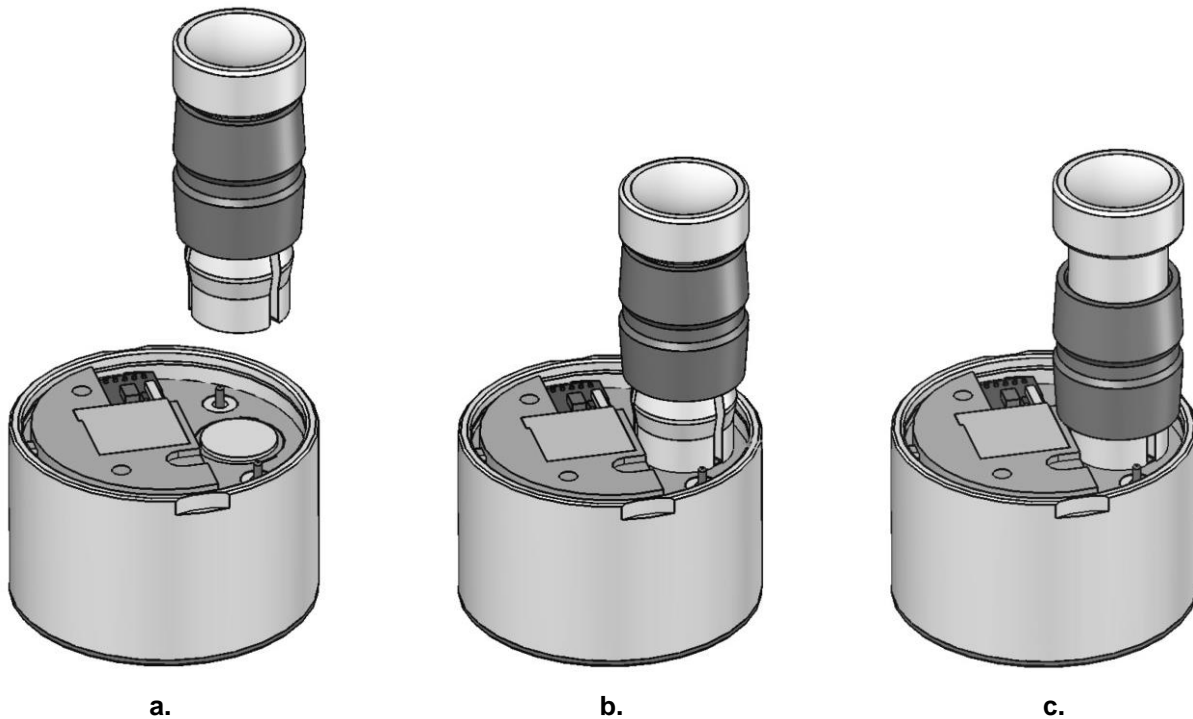

AreaRAE Plus & AreaRAE Pro User's Guide

9. Gently lift the PID lamp out of the sensor module by pulling up.

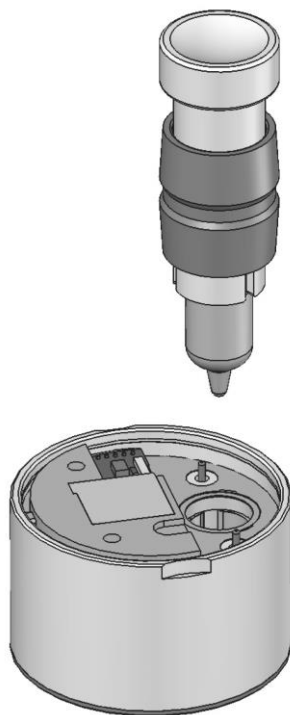

17.4.2.1. Cleaning The PID Electrode Panel

Place the PID electrode panel into isopropanol. It is highly recommended that an ultrasound bath to be used to clean it for at least 15 minutes. Then dry the electrode panel thoroughly. Never touch the electrodes with your hand.

Also use an isopropanol-soaked cotton swab to wipe off the lamp housing where it contacts the sensor when the sensor is installed.

Turn over the Electrode Panel so that the pins point up and the sensor cavity is visible. Examine the sensor electrodes for any corrosion, damage, or bending out of alignment. The metal sensor electrode “fingers” should be flat and straight. If necessary, carefully bend the sensor fingers to ensure that they do not touch the Teflon portions and that they are parallel to each other. Make sure that the nuts on the sensor pins are snug but not overtight. If the sensor is corroded or otherwise damaged, it should be replaced.

17.4.2.2. Cleaning The Lamp Housing Or Changing The Lamp

If the lamp does not turn on, the instrument will display an error message to indicate replacement of the lamp may be required.

1. If the lamp is operational, clean the lamp window surface and the lamp housing by wiping it with isopropanol using a cotton swab using moderate pressure. After cleaning, hold the lamp up to the light at an angle to detect any remaining film. Repeat the process until the lamp window is clean. Never use water solutions to clean the lamp. Dry the lamp and the lamp housing thoroughly after cleaning.

CAUTION: Never touch the window surface with the fingers or anything else that may leave a film. Never use acetone or aqueous solutions.

2. If the lamp does not turn on, remove the lamp from the lamp housing. Insert the new lamp, avoiding contact with the flat window surface.

AreaRAE Plus & AreaRAE Pro User's Guide

3. Reinstall the PID sensor module by pressing it into place with a soft, non-woven cloth. It is not necessary to press excessively. When the Electrode Panel and Lamp Housing Cap are replaced, the PID sensor will be properly seated.
4. Inspect the two electrical contacts (pins) to make sure they are not pressed down.
5. Replace the Electrode Panel.

IMPORTANT!

Make sure the Electrode Panel is inserted with the correct side up. The bottom of the Electrode Panel is larger than the top, and it fits into the top of the Sensor Module directly over the PID Lamp Window (the word "UP" is imprinted on the top of the Electrode Panel). If the Sensor Electrode Panel is upside down, it will not function correctly and the cover for the Sensor Module cannot close completely.

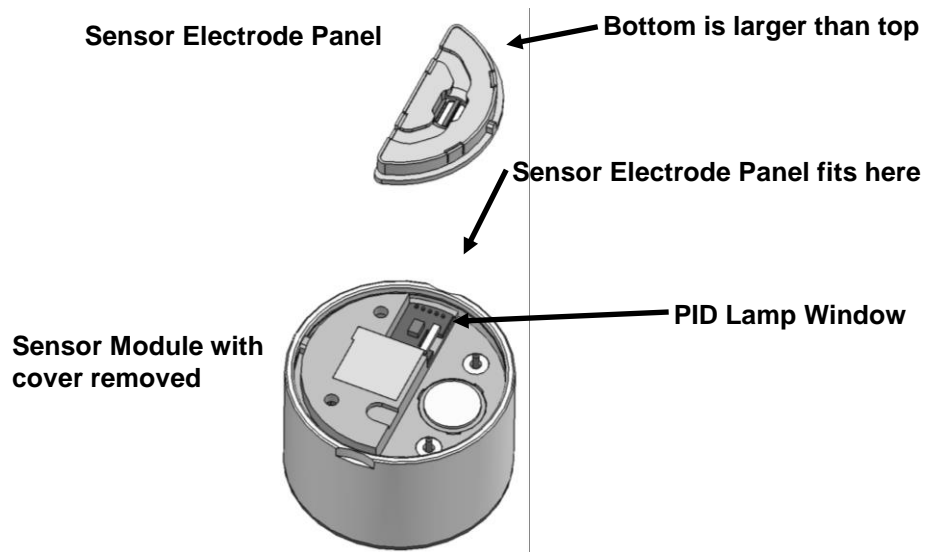

5. Replace the Lamp Housing Cap.

Note: Always fully calibrate the AreaRAE Plus/Pro after replacing the sensor module and/or lamp.

AreaRAE Plus & AreaRAE Pro User's Guide

17.5 Replacing The Sensor Compartment Cover

Before replacing the sensor compartment cover, inspect the large O-ring gasket for damage. If it is damaged, discard it and use a new one.

1. Place the O-ring gasket in the compartment. (Inspect the O-ring gasket for wear or damage first. If necessary, replace it.)
2. Press all the sensors firmly in place to ensure they are seated correctly.
3. Set the sensor compartment cover on top of the compartment.
4. Tighten the four screws. **Note:** Do not overtighten.

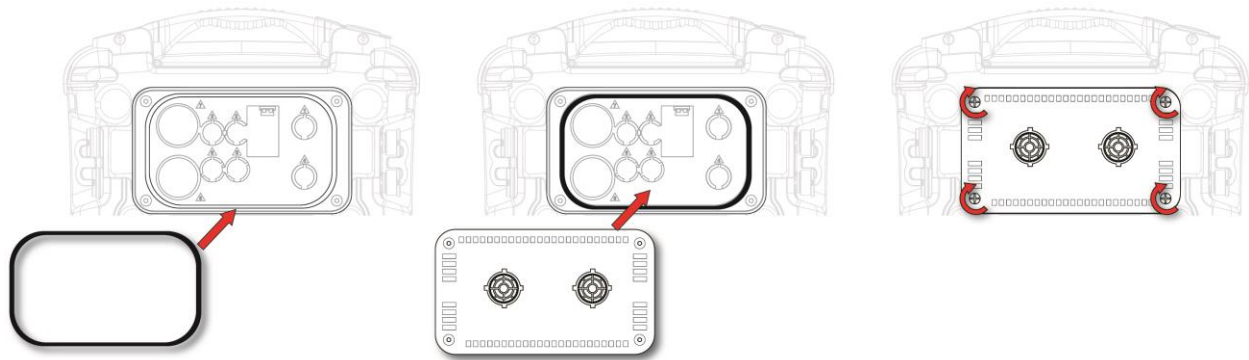

17.6 Battery Removal/Replacement

The battery is located in a bay in the lower half of the AreaRAE Plus/Pro's back.

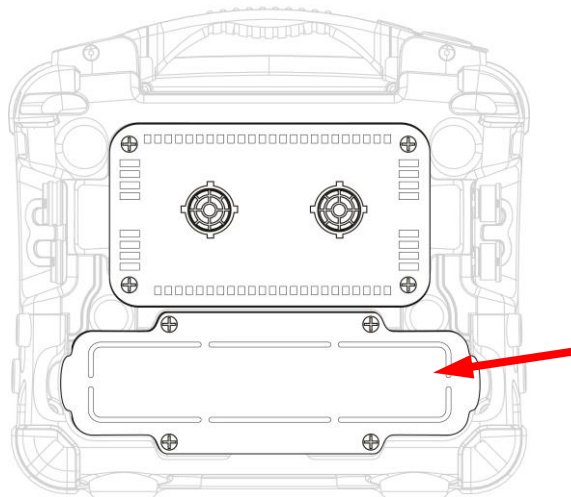

Changing the AreaRAE Plus/Pro battery pack requires a Philips screwdriver. To replace the AreaRAE Plus/Pro battery:

1. Turn the instrument off.
2. Remove the filter from the front of the instrument.
3. Place the instrument face-down on a soft surface.
4. Remove the four screws that hold the battery.

AreaRAE Plus & AreaRAE Pro User's Guide

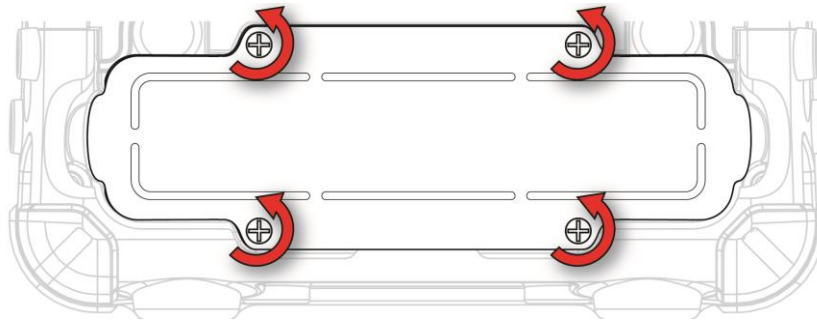

5. Use your fingers to lift the battery out (there are indents at each end):

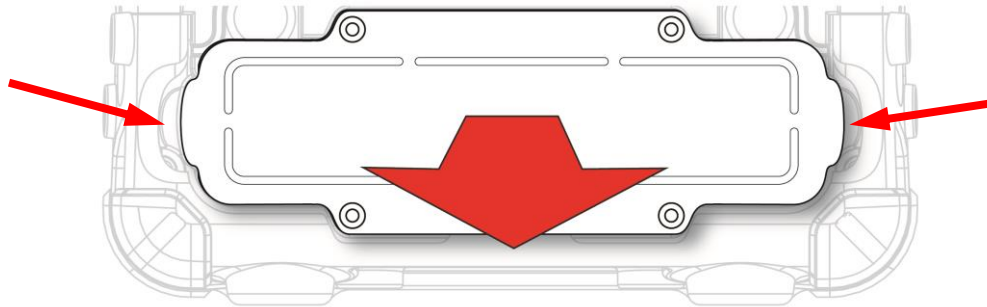

6. Slide a new battery into place.
7. Tighten the four screws.

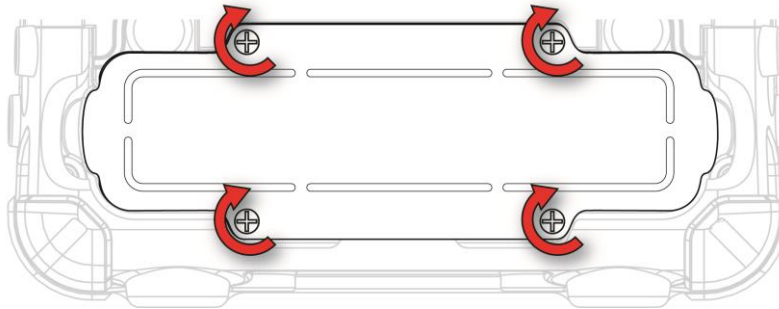

WARNING

To reduce the risk of ignition of hazardous atmospheres, recharge, remove or replace the battery only in an area known to be non-hazardous!

AreaRAE Plus & AreaRAE Pro User's Guide

17.7 RAEMet Meteorological Sensor (Optional)

If your AreaRAE Plus/Pro is equipped with a RAEMet meteorological sensor (P/N: C04-0970-000), it is typically removed for storage and must be attached before using it.

1. If the AreaRAE Plus/Pro is on, turn it off. (Never attach or remove the RAEMet sensor without first turning off the instrument's power.)
2. Lift up the weather-tight rubber cover, located at the end of the handle, to expose the RAEMet receptacle.

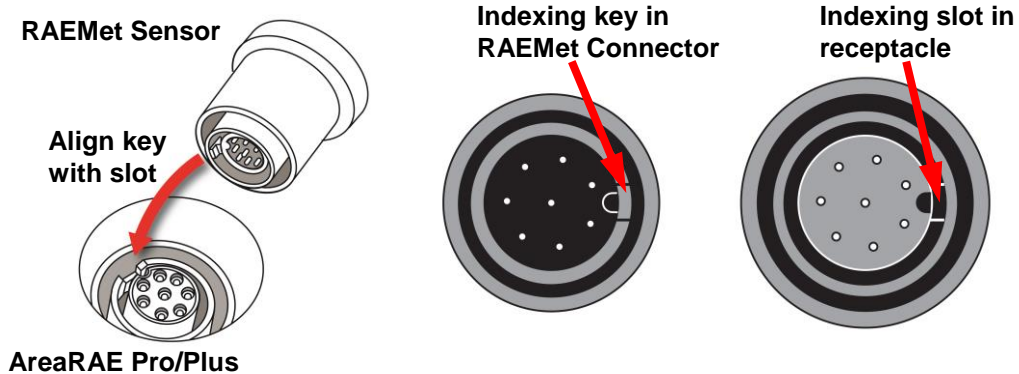

3. Align the RAEMet's connector plug with the AreaRAE Plus/Pro's receptacle using the indexing key and slot as a guide.
4. Press the RAEMet's base into place, and then turn the locking ring to tighten the connection. Never force the connector in or out of the receptacle.
5. Tighten the *locking ring* until the RAEMet sensor is firmly seated. Do not turn the entire RAEMet sensor.

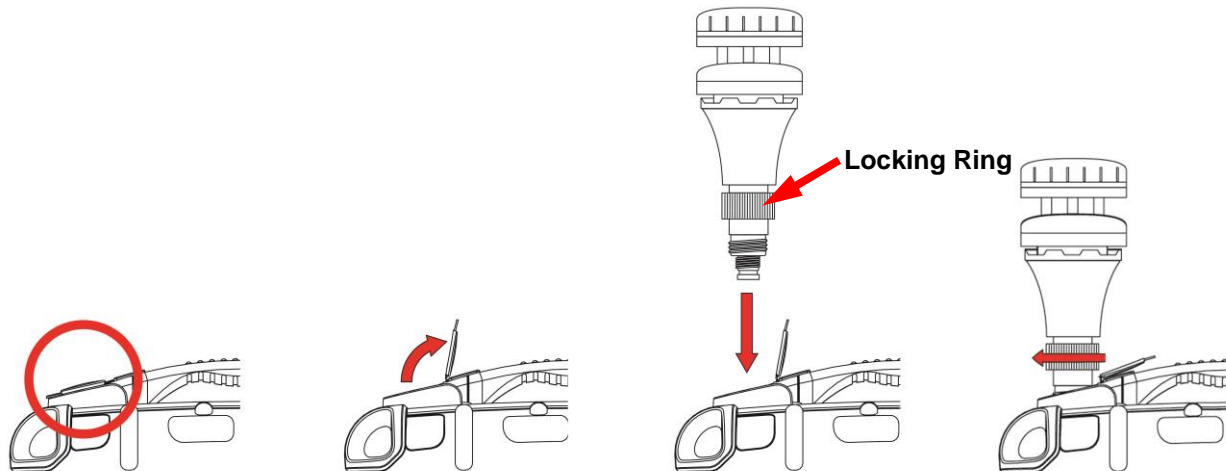

IMPORTANT!

If the RAEMet and AreaRAE receptacle are not aligned properly, electrical connections will not be made and the RAEMet sensor will not operate. Also, when the RAEMet sensor is not attached to the instrument, make sure the cover is securely closed to keep moisture and debris from entering the base.

Note: Do not remove the RAEMet sensor from the instrument while it is in operation. If it is removed from the AreaRAE Plus/Pro during operation, the display shows a "Fail" message to alert you.

Note: Keep strong magnets away from the RAEMet sensor. It contains a compass, and strong magnetism can affect its accuracy.

17.8 Antenna Installation

Attach the antenna by opening the compartment, aligning the antenna, and turning the base of the antenna until it is snug.

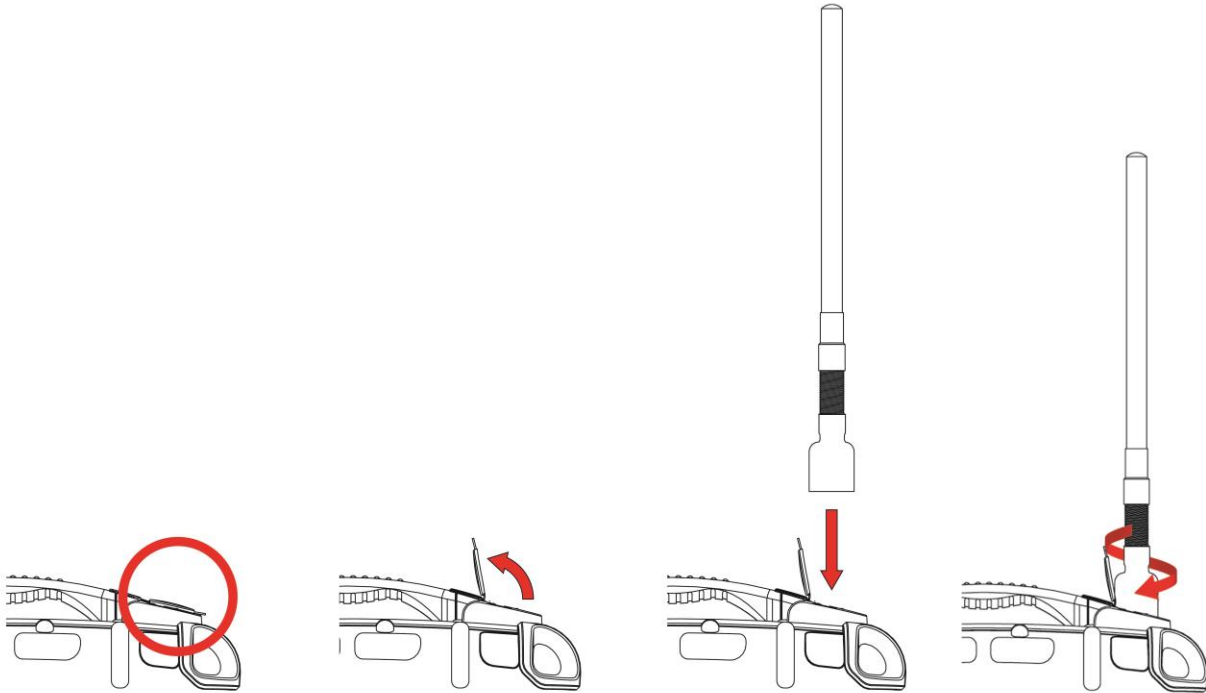

IMPORTANT!

When the antenna is not attached to the instrument, make sure the cover is securely closed to keep moisture and debris from entering the base.

17.9 VOC Carbon Filter For CO Sensor

When using a 4R+ CO (carbon monoxide) sensor in an environment with VOCs, it is recommended to use a carbon filter (P/N: W01-3019-000) on the sensor to absorb excess VOCs. This minimizes sensor “overshoot.” Replace the filter periodically for best performance.

1. Remove the four screws holding the gas plate in place. (Refer to page 92 for details.)
2. Remove the gas plate.
3. Place the filter over the CO sensor, with the filter’s fabric side facing up.
4. Replace the gas plate. (Refer to page 102 for details.)
5. Tighten the four screws.
6. Start the AreaRAE Plus/Pro.
7. Recalibrate the CO sensor.

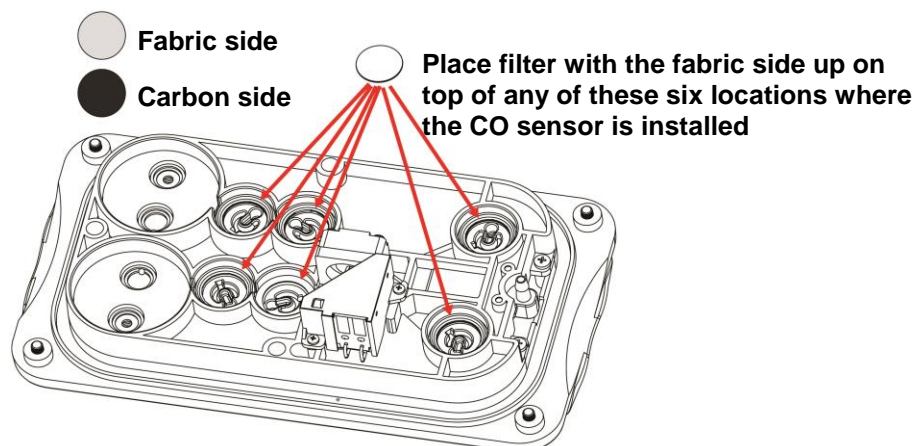

For further information on using a carbon filter to reduce cross-sensitivity to VOCs on a CO sensor, refer to RAE Systems Technical Note TN-121, available at www.raesystems.com.

17.10 Exhaust Gas Collector For Diverting Output Or Collecting Gas Samples

Diverting output gas or collecting samples requires an Exhaust Gas Collector assembly (P/N: W01-3020-000), which includes the Gas Collector Plate and these parts: a male luer connector (P/N: 400-0073-000) and Tygon tubing (P/N: 411-0018-037). Capturing samples requires a Tedlar sample collection bag (3 liters, P/N: 500-0003-000).

Note: When collecting samples for evidence or later analysis, it is recommended to use only the PID sensor.

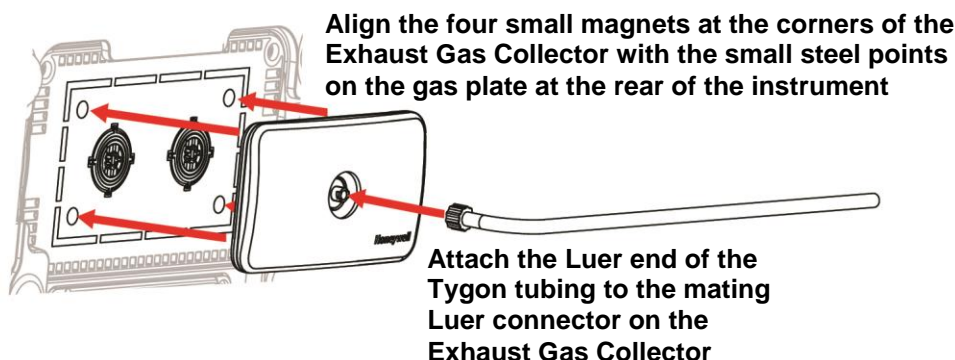

Important! Remove the Exhaust Gas Collector after capturing samples. Do not leave the Exhaust Gas Collector attached during continuous monitoring.

AreaRAE Plus & AreaRAE Pro User's Guide

17.11 Base Plate For Tripod Mounting (Optional)

An optional base plate is available (P/N: W01-3018-000) with two hex screws (P/N: 430-0409-000) for mounting an AreaRAE Plus/Pro on a standard surveyor-style tripod (such as RAE Systems P/N: 029-2117-000). The base plate comes with two hex screws that match the threaded inserts in the bottom of the AreaRAE Plus/Pro. **Note:** Installation does not require removal of the instrument's rubber boot.

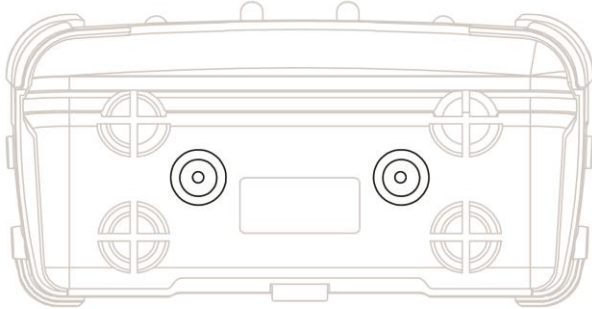

1. Lay the AreaRAE Plus/Pro on its back to provide access to the two threaded inserts.

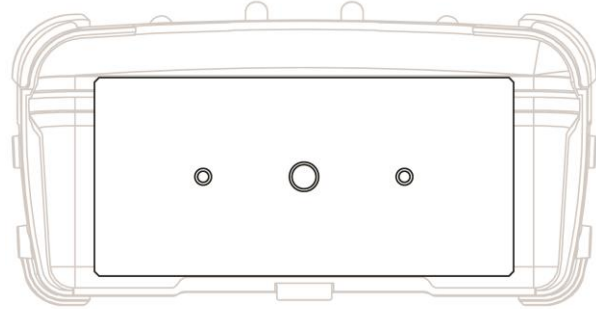

2. Match the plate to the instrument, with its rib against the instrument's bottom.



3. Align the hex-head screws with the holes and press them into place.



4. Use a hex wrench to tighten the screws.

Once the base plate is firmly attached to the AreaRAE Plus/Pro, stand the instrument up and set it on the tripod. Press up on the tensioning knob until it meets the threads in the middle of the base plate, and then turn until the assembly is tight.

AreaRAE Plus & AreaRAE Pro User's Guide

17.12 Replacing The Pump

If your AreaRAE Plus/Pro's pump requires replacement, follow these steps.

IMPORTANT! Turn off the instrument and remove the battery before proceeding.

IMPORTANT! Remove the external filter before proceeding.

1. Remove the sensor compartment cover.

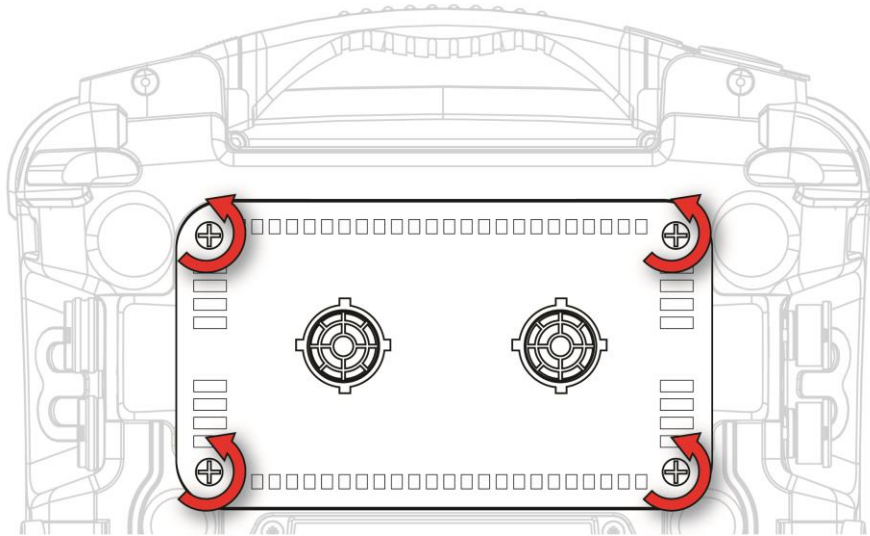

2. Turn it upside down and set it on a soft flat surface.
3. The pump assembly is attached to the sensor compartment cover with two Philips screws. Remove the two screws.

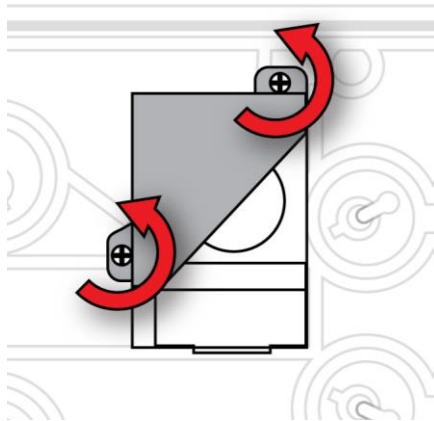

4. Lift off the pump assembly.
5. Pressing down on the gas plate with one hand, disconnect the pump from internal tubing by gently pulling it out. It has an inlet and outlet that are held in the two holes with rubber O-ring gaskets.
6. Install two new O-ring gaskets (P/N: 430-B081-0H0) in the compartment's inlet and outlet.

AreaRAE Plus & AreaRAE Pro User's Guide

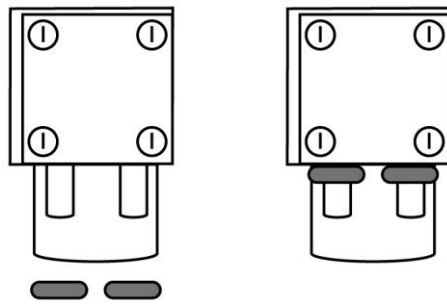

7. Press a new pump assembly (P/N: W01-3002-000) into place, making sure that both the inlet and outlet from the pump go through the O-rings into the two holes.
9. Insert and tighten the two screws that attach the bracket to the housing.
10. Replace the cover.
11. Turn on the instrument and check for proper pump operation.

18 Alarms Overview

The AreaRAE Plus/Pro provides an unmistakable four-way alarm notification system that combines local alarms on the device with real-time remote wireless alarm notification (if the instrument is equipped with wireless functionality and it is active). Local alarms include audible buzzer alarm, visible alarm via bright LED lights, and an alarm notification on the display. These can be selectively turned on or off.

18.1 Alarm Signals

During each measurement period, the gas concentration and radiation levels are compared with the programmed alarm limits for Low, High, TWA, STEL, and other alarms, as applicable. If the concentration exceeds any of the preset limits, the alarms are activated immediately to warn both the AreaRAE Plus/Pro user and a remote safety officer (if wireless is enabled) of the alarm condition. In addition to gas and radiation alarms, other alarms are available.

Furthermore, the AreaRAE Plus/Pro alarms if one or more of the following conditions occurs: battery voltage low, pump blocked, PID lamp failed, etc.

When the low battery alarm occurs, there may be approximately 15 minutes of operating time remaining. In this case, it is recommended that you promptly change or charge the battery in a non-hazardous location.

18.2 Changing The Alarm Mode

Your choices are Auto Reset and Latched. A latched alarm stays on until you acknowledge the alarm by pressing a button. An auto-reset alarm turns off when the condition that set off the alarm is no longer present (for instance, a high H₂S reading that exceeds the preset threshold and triggers an alarm, but then lowers below that threshold, turning the alarm off).

1. Enter the Alarm Mode sub-menu of the Alarms section under the Programming Menu.
2. Select Auto Reset or Latched by pressing [N/-] to select the mode, and [Y/+] to confirm the choice.
3. Press [Y/+] to save your selection.

19 Diagnostic Mode

In Diagnostic Mode, the AreaRAE Plus/Pro provides raw counts for sensor, battery, and other readings, as well as a list of installed sensors and information about them (expiration date, serial number, etc.). Most of these screens are useful only to service technicians. Many allow access for changing settings.

Diagnostic Mode can only be accessed at startup time. In Diagnostic Mode, readings are displayed in raw counts instead of parts per million (ppm) or other units of measure.

19.1 Enter Diagnostic Mode

1. With the instrument turned off, press and hold [Y/+] and [MODE] until the AreaRAE Plus/Pro starts up.
2. After startup, enter the password when prompted (default is "0000") and press [MODE].

Once Diagnostic Mode is active, step from screen to screen by pressing [N/-].

19.2 Adjusting Alarm LEDs & Buzzer

The buzzer, green LEDs, red LEDs, and backlight can be turned on or off in Diagnostic mode. In addition, you can adjust the repetition rate and loudness of the buzzer and the repetition rate and brightness of the LEDs.

1. Start with the instrument turned off. Hold down the [Y/+] and [MODE] keys until the AreaRAE Plus/Pro starts.
2. When you see the password screen, input your 4-digit password, and then press [MODE].
3. Once you have entered Diagnostic Mode, press [N/-] until the "Alarm" screen is displayed.
4. Press [MODE] to step through the menu items; press [Y/+] to make a change, and press [N/-] to advance to the next menu.

Important! When you are done, exit Diagnostic Mode and test the instrument before actual use.

19.3 Adjusting LCD Contrast

The display's contrast can be adjusted in Diagnostic mode.

1. Start with the instrument turned off. Hold down the [Y/+] and [MODE] keys until the AreaRAE Plus/Pro starts.
2. When you see the password screen, input your 4-digit password, and then press [MODE].
3. Once you have entered Diagnostic Mode, press [N/-] until the "LCD Contrast" screen is displayed.
4. Press [Y/+] to increase the value; press [MODE] to decrease the value, and press [N/-] to advance to the next menu.

Important! When you are done, exit Diagnostic Mode and test the instrument before actual use.

19.4 Pump Stall Threshold Adjustment

Proper setting of the pump stall threshold is necessary so that if there is an obstruction to the inlet, the pump will stop and the instrument will go into alarm. This prevents unwanted debris or liquid from entering the pump and causing disruption or damage. The AreaRAE Plus/Pro provides two methods to set the pump stall threshold: Static and Dynamic.

Note: The Dynamic method uses an algorithm that takes external temperature into consideration for greater accuracy.

AreaRAE Plus & AreaRAE Pro User's Guide

If it is necessary to set the pump stall threshold, you must enter Diagnostic Mode. Also, regardless of which method is used, when you are done setting thresholds, exit Diagnostic Mode and test the instrument before actual use.

19.4.1 Entering Diagnostic Mode To Set The Pump Stall Threshold

5. Start with the instrument turned off. Hold down the [Y/+] and [MODE] keys until the AreaRAE Plus/Pro starts.
6. When you see the password screen, input your 4-digit password, and then press [MODE].
7. Once you have entered Diagnostic Mode, press [N/-] until the “Pump” screen is displayed.
8. Set the high and low threshold settings for pump stall using the instructions in this section. Press [MODE] to step through the menu items; press [Y/+] to make a change, and press [N/-] to advance to the next menu.

19.4.2 Selecting The Pump Stall Threshold Method

At the Pump screen, the settings are shown, including the Pump Speed and Pump Stall Algorithm (which can be Dynamic or Static).

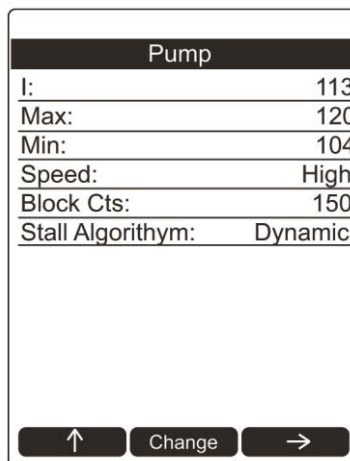

Pump	
l:	113
Max:	120
Min:	104
Speed:	High
Block Cts:	150
Stall Algorithm:	Dynamic

To change the pump Speed or Stall Algorithm setting:

1. Press [MODE]. Either the pump Speed or the Stall Algorithm is highlighted.
2. To change from “High” to “Low” or “Dynamic” to “Static,” press [Y/+].

Important! The pump Speed must be set to “High” in order to access Dynamic pump stall settings.

Now follow directions to change the pump stall threshold values, using the method that matches your choice of either Dynamic or Static.

AreaRAE Plus & AreaRAE Pro User's Guide

19.4.3 Setting Pump Stall Threshold Values – Dynamic Method

When the Dynamic pump stall threshold values are shown, you can perform calibration to set the pump stall values dynamically.

Pump - Dynamic	
RT Stall/T:	263/26
Calib In High Speed	
Calib.Temp (C):	25
Idle Cts:	180
Block Cts:	150
Stall Cts:	265

Back Calib ↓

Press [MODE] to begin calibration. This screen is shown, indicating that it is ready:

Pump - Dynamic	
Calibrating Pump Idle. Do Not Block The Inlet. Press Start.	

Back Start []

Press [MODE] to begin calibration. There is a countdown shown in the box. Press [N/-] anytime to abort the calibration and go back.

Pump - Dynamic	
Real Time Cts:	111
Calibrating Pump Idle.	
15	

Back Start []

AreaRAE Plus & AreaRAE Pro User's Guide

Once the countdown is finished, this message is displayed:

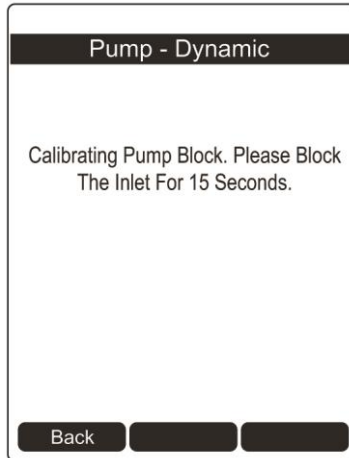

Hold your finger over the inlet, and allow the countdown to proceed. Press [Y/+] anytime to abort and return to the previous screen.

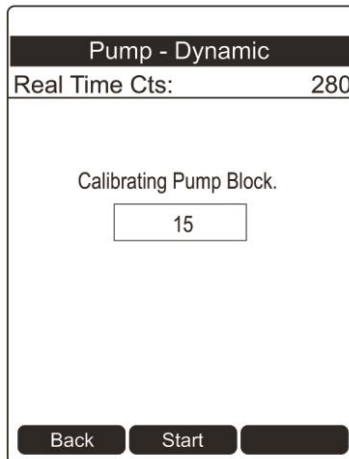

When the countdown is finished, the main Dynamic pump stall screen is shown.

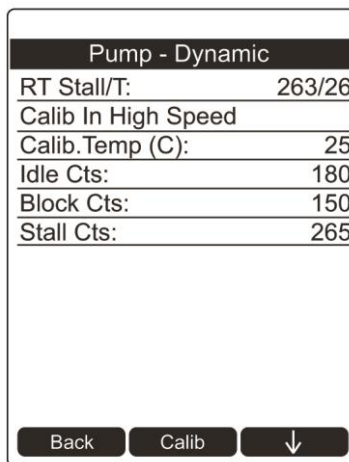

Dynamic pump stall calibration is complete. You can now exit Diagnostic Mode.

AreaRAE Plus & AreaRAE Pro User's Guide

Important! When you are done setting thresholds, exit Diagnostic Mode and test the instrument before actual use.

19.4.4 Setting Pump Stall Threshold Values – Static Method

Use the following values for reference when using the Static method to adjust the pump stall threshold values:

	Low Speed	High Speed
Vacuum	≤ -2.5 in Hg	≤ -9.6 in Hg
Flow rate	>200 cc/min	>400 cc/min
Idle (I)	100 to 200 counts	150 to 250 counts
Block	(Block-Idle) > 100 counts	(Block-idle) > 100 counts
Stall Setting	(Idle + Block)/2	(Idle + Block)/2

19.4.4.1. Stall High Threshold Setting – Static Method

In Diagnostic Mode, press the [MODE] key repeatedly until the “Pump” screen is displayed. “High” should be highlighted. Otherwise, press [Y/+] to select the “High” value.

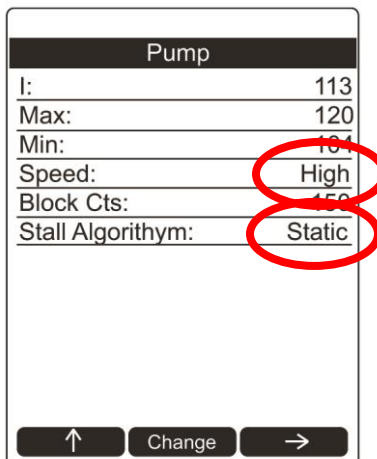

- The Idle value (shown as a value for “I”) should be 150 to 250. Record the value.
- Block the inlet, and record the value after it goes up.
- The blocked value minus the Idle (Unblocked) value should be greater than 100 counts: (Blocked value – Unblocked value) > 100 .
- If it is greater than 100, then the pump is working correctly and tubing leading from the inlet is not leaking.
- To calculate the best High value, first add the Blocked and Unblocked values and divide by 2: (Blocked value + Unblocked value) / 2 = correct Stall High value.
- Press [N/-] to advance to the next Pump screen.
- Use the [Y/+] and [N/-] keys to increase or decrease the high value input the results of your calculation.
- Press [MODE] to register that value.

AreaRAE Plus & AreaRAE Pro User's Guide

19.4.4.2. Verifying the Stall High Setting

Exit Diagnostic Mode. In Normal Mode, with the pump at high speed, block the inlet. The pump should stall after a few seconds, sending the instrument into alarm. This tells you that the pump's Stall High setting is correct.

- If the gas inlet is blocked but the pump does not shut down, or the pump shuts down too easily with a slight blockage, the pump stall threshold value may be set too high or too low.
- If the pump does not stall or send the instrument into alarm, then there may be a leak in the gas inlet or the pump is weak or defective and should be replaced.

19.4.4.3. Stall Low Threshold Setting - Static

In Diagnostic Mode, press the [MODE] key repeatedly until the "Pump" screen is displayed. "Low" should be highlighted. Otherwise, press [Y/+] to select the "Low" value.

- The Idle (shown as a value for "I") value should be 100 to 200. Record the value.
- Block the inlet, and record the value after it goes up.
- The blocked value minus the idle (unblocked) value should be greater than 100 counts:
(Blocked value – Unblocked value) > 100
- If it is greater than 100, then the pump is working correctly and tubing leading from the inlet is not leaking.
- To set the Low value, first add the blocked and unblocked values and divide by 2:
(Blocked value + Unblocked value) / 2 = correct Stall Low value
- Then, using the [Y/+] and [N/-] keys, set the Stall Low value to this number.

19.4.4.4. Verifying the Stall Low Setting - Static

Exit Diagnostic Mode. In Normal Mode, block the inlet. The pump should stall after a few seconds, sending the instrument into alarm. This tells you that the pump's Low setting is correct.

- If the gas inlet is blocked but the pump does not shut down, or the pump shuts down too easily with a slight blockage, the pump stall threshold value may be set too high or too low.
- If the pump does not stall and send the instrument into alarm, then there may be a leak in the gas inlet or the pump is weak or defective and should be replaced.

Important! When you are done setting thresholds, exit Diagnostic Mode and test the instrument before actual use.

19.5 Exit Diagnostic Mode

Hold [MODE] until the AreaRAE Plus/Pro shuts off. When you start it up again, it is in normal operating mode.

AreaRAE Plus & AreaRAE Pro User's Guide

19.6 Alarm Signal Summary

19.6.1 Hygiene Mode

Alarm Type	Buzzer & LED	Display	Reading	Backlight	Priority
Fail	3 beeps/sec	“Fail”	Blinking reading	On	Highest
Fail	3 beeps/sec	“Over” or “Fail” at LEL sensor location, depending on signal	Blinking Reading	On	
Fail	3 beeps/sec	“Lamp” at PID location	Blinking reading	On	
Pump	3 beeps/sec	Blinking pump symbol	Reading	On	
Max	3 beeps/sec	“Max” at sensor location	Blinking reading	On	
Over Range	3 beeps/sec	“Over” at sensor location	Blinking 9999	On	
High	3 beeps/sec	“High” at sensor location	Reading	On	
Low	2 beeps/sec	“Low” at sensor location	Reading	On	
Negative	1 beep/sec	“Neg” at sensor location	0	On	
STEL	1 beep/sec	“STEL” at sensor location	Reading	On	
TWA	1 beep/sec	“TWA” at sensor location	Reading	On	
Calibration Fail	1 beep/sec	“Cal” at sensor location	Reading	On	
Bump Fail	1 beep/sec	“Bump” at sensor location	Reading	On	
Datalog Full	1 beep/sec	Blinking datalog symbol	Reading	On	
Calibration Required	-	“Full” Bottle symbol	Reading	-	
Bump Required	-	“Empty” Bottle symbol	Reading	-	
Battery	1 beep/min	Blinking battery symbol	Reading	Stays as is	
Comfort Beep	1 beep/min no LED flash	-	Reading	-	Lowest

Notes

“Negative” means that the true sensor reading is below zero, even though a zero reading is shown for the sensor.

AreaRAE Plus & AreaRAE Pro User's Guide

19.6.2 General Alarms

Message	Condition	Alarm Indications
HIGH	Gas exceeds "High Alarm" limit	3 beeps/flashes per second
OVR	Gas exceeds sensor's measurement range	3 beeps/flashes per second
MAX	Gas exceeds electronic circuit's maximum range. If alarm persists in clean air, it indicates a fault sensor.	3 beeps/flashes per second
LOW	Gas exceeds "Low Alarm" limit*	2 beeps/flashes per second
TWA	Gas exceeds "TWA" limit	1 Beep/flash per second
STEL	Gas exceeds "STEL" limit	1 Beep/flash per second
Crossed pump icon flashes	Inlet blocked or pump failure	3 beeps/flashes per second
"Lamp" flashes	PID lamp failure	3 beeps/flashes per second
Empty battery icon flashes	Low battery	1 flash, 1 beep per minute
CAL	Calibration failed, or needs calibration	1 beep/flash per second
NEG	True sensor reading is below zero, even though a zero reading is shown for the sensor. If alarm persists in clean air, it indicates a fault sensor.	1 beep/flash per second

* For oxygen, "low alarm limit" means a concentration is lower than the low alarm limit.

20 Troubleshooting

Problem	Possible Reasons & Solutions
Cannot turn on power after charging the battery	<p>Reasons: Defective charging circuit. Defective battery.</p> <p>Solutions: Replace battery or charger. Try charging battery again.</p>
Lost password	<p>Solutions: Call Technical Support at +1 408-952-8461 or toll-free at +1 888-723-4800</p>
Buzzer, LED lights inoperative	<p>Reasons: Buzzer and/or other alarms disabled. Bad buzzer, LED lights, or PCB.</p> <p>Solutions: Check under “Alarm Settings” in Programming Mode that buzzer and/or other alarms are not turned off. Call authorized service center.</p>
“Lamp” message when power on. Lamp alarm.	<p>Reasons: Low ion concentration inside PID lamp especially in cold environment when first powered on. Defective PID lamp or defective circuit.</p> <p>Solutions: Turn the unit off and back on. Replace UV lamp.</p>
Pump failed message. Pump alarm.	<p>Reasons: Inlet probe blocked. Direct connection to a gas outlet while the gas value is turned off. Water trap filter sucks in water. Water trap filter too dirty. Water condensed along the inlet probe. Bad pump or pump circuit.</p> <p>Solutions: Remove the blocking objects and then press [Y/+] key to reset the pump alarm. Replace contaminated water trap filter. Be careful not to allow water condensation inside the unit. Replace the pump.</p>

If you need replacement parts, a list is available online:

www.raesystems.com

AreaRAE Plus & AreaRAE Pro User's Guide

21 Specifications

Dimensions	12.6" x 12.4" x 6.3" (322 mm x 315 mm x 160 mm) with boot
Weight	13.67 lbs (6.3 kg)
Gas Sensor Slots	7 total; see Sensor list on this page
Additional Sensors*	Gamma, RAEMet (wind speed, wind direction, temperature, humidity)
GPS	Installed at factory
Battery	Rechargeable 7.2V Li-ion battery pack with built-in charger
Battery Charging Time	<10 hrs
Operating Hours	Approximately 16 hours with wireless connectivity, GPS, and all sensors operational
Power input	AC adapter with Input 110-240 V AC
Display	Large 240x320 pixel LCD display 2.5" x 3.34" (63.59 mm x 84.79 mm)
Keypads	3 operation and programming keys
Alarms	High/Low limits for gases and radiation detectors, STEL, TWA limits for EC sensors, low battery, sensor, or pump failure
Visible Alarm	Bright LED, 360-degree view
Audible Alarm	Dual buzzers: 108 dB @ 1 m
Data logging	Continuous datalogging (90 days for 12 gas sensors and GPS at 1-minute intervals, continuously)
Data Storage	24M bytes (memory-full action: stop when full or wrap-around)
Data Interval	User-configurable from 1 to 3,600 sec
Wireless	<ul style="list-style-type: none"> • Long Range: ISM License-free 900 to 928 MHz or 2.4GHz • Optional Wi-Fi • Secondary: Mesh Network
FCC Compliance	FCC Part 15
Communication	Communicates to ProRAE Studio via USB cable to PC; Wireless data and alarm status transmission via Wi-Fi or ISM modem; Acts as gateway to connect up to 8 remote Mesh-module equipped instruments
Safety Certification	Class I, Division 2 Groups A, B, C, D T4
Sampling Pump	Built-in pump, typical flow rate 450 cc/min
Temperature	-20° C to 50° C (-4° F to 122° F)
Humidity	0% to 95% relative humidity (non-condensing)
Ingress Protection (IP)	IP-65 (third-party tested)
Languages	Chinese, Dutch, English, French, German, Italian, Portuguese, Russian, Spanish
Warranty	<ul style="list-style-type: none"> • Four years for O2 Liquid Oxygen sensors • Three years for CO and H₂S sensors • Two years for non-consumable components and catalytic LEL sensor • Two years for 10.6eV 7R+ PID lamp • One year on all other sensors, battery, and other consumable parts • Six months for 9.8eV lamp PID sensor

* Optional sensors.

Specifications are subject to change.

AreaRAE Plus & AreaRAE Pro User's Guide

21.1 AreaRAE Plus/Pro Wireless Configurations

	Primary Radio Long Distance		Secondary Radio Short Distance	GPS	BLE	AreaRAE Pro	AreaRAE Plus	
	ISM	Wi-Fi	Mesh			Model	Model	
Americas	1	900 MHz	N/A	900MHz	Y	Y	PGM-6560A	PGM-6520A
	2	N/A	Y	900MHz	Y	Y	PGM-6560E	PGM-6520E
	3	900MHz	Y	900MHz	Y	Y	PGM-6560D	PGM-6520D
	4	2.4GHz	N/A	900MHz	Y	Y	PGM-6560B	PGM-6520B
EMEA	1	2.4GHz	N/A	869MHz	Y	Y	PGM-6560B	PGM-6520B
Asia/Pacific	1	900MHz	N/A	900MHz	Y	Y	PGM-6560A	PGM-6520A
	2	2.4GHz	N/A	900MHz	Y	Y	PGM-6560B	PGM-6520B
China	1	2.4GHz	N/A	869MHz	Y	Y	PGM-6560B	PGM-6520B
	2	N/A	Y	869MHz	Y	Y	PGM-6560E	PGM-6520E

AreaRAE Plus & AreaRAE Pro User's Guide

21.2 Sensor Specifications

Radiation Sensor	Range	Resolution
Gamma	0 to 20,000 μ Rem/h	1 μ Rem/h
PID Sensors for VOC	Range	Resolution
4R+; 10.6eV* ppb	0 to 2,000 ppm	10 ppb
4R+ 9.8 eV	0 to 2,000 ppm	0.1 ppm
7R+ 10.6 eV* ppb	0 to 2,000 ppm	10 ppb
7R+ 10.6 eV (Extended Range)	0 to 5,000 ppm	0.1 ppm
Combustible Sensor	Range	Resolution
4R+ LEL	0 to 100% LEL	1% LEL
Carbon Dioxide Sensor	Range	Resolution
Carbon Dioxide (CO ₂) NDIR	0 to 50,000 ppm	100 ppm
Electrochemical Sensors	Range	Resolution
Ammonia	0 to 100 ppm	1 ppm
Carbon Monoxide	0 to 500 ppm	1 ppm
Carbon Monoxide	0 to 2,000 ppm	10 ppm
Carbon Monoxide (H ₂ -comp)	0 to 2,000 ppm	10 ppm
Chlorine	0 to 50 ppm	0.1 ppm
Chlorine dioxide	0 to 1 ppm	0.03 ppm
Ethylene Oxide ETO-A	0 to 100 ppm	0.5 ppm
Ethylene Oxide ETO-B	0 to 10 ppm	0.1 ppm
Ethylene Oxide ETO-C	0 to 500 ppm	10 ppm
Hydrogen	0 to 2,000 ppm	2 ppm
Hydrogen Chloride	0 to 15 ppm	1 ppm
Hydrogen Cyanide	0 to 50 ppm	0.5 ppm
Hydrogen Fluoride	0.5 to 10 ppm	0.1 ppm
Hydrogen Sulfide	0 to 100 ppm	0.1 ppm
Hydrogen Sulfide extended	0 to 1,000 ppm	0.1 ppm
Liquid Oxygen	0 to 30%	0.1%
Sulfur Dioxide	0 to 20 ppm	0.1 ppm
Nitric Oxide	0 to 250 ppm	1 ppm
Nitrogen Dioxide	0 to 20 ppm	0.1 ppm
Phosphine	0 to 20 ppm	0.1 ppm

Specifications are subject to change without notice.

AreaRAE Plus & AreaRAE Pro User's Guide

LEL Range, Resolution & Response Time

Range	Resolution	Response Time
0-100%	1 %	15 sec

LEL Correction Factors

Compound	100% LEL (Vol %)	LEL CF*
Acetone	2.5	<i>1.9</i>
Ammonia	15	1.0
Benzene	1.2	2.1
Butane, n-	1.9	<i>1.9</i>
Carbon monoxide	12.5	<i>1.3</i>
Cyclohexane	1.3	2.1
Ethanol	3.3	<i>1.8</i>
Ethyl acetate	2	2.4
Gasoline	1.3	2.6
Heptane, n-	1.1	2.5
Hexane, n-	1.1	2.1
Hydrogen	4	1.0
Isobutene (Isobutylene)	1.8	1.6
Isopropanol	2	2.2
Methane	5	1.0
Methanol	6	1.6
Methyl ethyl ketone	4.5	2.2
Octane, n-	1	2.7
Propane	2.1	1.4
Propene	2	<i>1.6</i>
Toluene	1.1	2.4
Turpentine	0.8	<i>3.0</i>

Note: Values in **bold** type are confirmed with RAE Systems by Honeywell instruments. Others, shown in *italic*, are calculated from diffusion models.

* These figures are for guidance only and are rounded to the nearest 5%. For the most accurate measurements, the instrument should be calibrated with the gas under investigation. See RAE Systems Technical Note TN-156 for more details and other compounds.

Caution:

Refer to RAE Systems Technical Note TN-144 for LEL sensor poisoning.

AreaRAE Plus & AreaRAE Pro User's Guide

Year Of Manufacture

To identify the year and month of manufacture, refer to the two-digit marking placed adjacent to the serial number on the instrument label according to the following table:

Year	First digit Year code	Month	Second digit Month code
2014	R	January	1
2015	S	February	2
2016	T	March	3
2017	U	April	4
2018	V	May	5
2019	W	June	6
2020	A	July	7
2021	B	August	8
2022	C	September	9
2023	D	October	A
2024	E	November	B
2025	F	December	C

E.G.: "RA" indicates that the monitor is manufactured in the month of October in the year 2014.

Technical Support

To contact RAE Systems Technical Support Team:

Monday through Friday, 7:00AM to 5:00PM Pacific (US) Time

Phone (toll-free): +1 888-723-4800

Phone: +1 408-952-8461

E-mail: RAE-tech@honeywell.com

Web Site: www.raesystems.com, www.honeywellanalytics.com

Outside the Americas:

E-Mail: HAexpert@honeywell.com

Honeywell Analytics Ltd.

4 Stinsford Road

Nuffield Industrial Estate

Poole, Dorset, BH17 0RZ

United Kingdom

Tel: +44 (0) 1202 645 544

Fax: +44 (0) 1202 645 555

Honeywell Analytics

Elsenheimerstrasse 43

80687 München

Germany

Tel: +49 89 791 92 20

Fax: +49 89 791 92 43

Honeywell Analytics

ZAC Athélia 4 – 375 avenue du Mistral

Bât B, Espace Mistral

13600 La Ciotat

France

Tel: +33 (0) 4 42 98 17 75

Fax: +33 (0) 4 42 71 97 05

Honeywell Analytics

P.O. Box-45595

6th Street

Musaffah Industrial Area

Abu Dhabi

UAE

Tel: +971 2 554 6672

Fax: +971 2 554 6672

22 RAE Systems by Honeywell Contacts

RAE Systems by Honeywell

World Headquarters

3775 N. First St.

San Jose, CA 95134-1708 USA

Phone: +1 408.952.8200

Fax: +1 408.952.8480

WORLDWIDE SALES OFFICES

USA/Canada: 1.877.723.2878

Europe: +800.333.222.44/+41.44.943.4380

Middle East: +971.4.450.5852

China: +86.10.5885.8788-3000



RAE Systems by Honeywell
3775 N. First St.
San Jose, CA 95134-1708 USA
Phone: 408.952.8200
Fax: 408.952.8480

E-mail (technical support): RAE-tech@honeywell.com
Web Site: www.raesystems.com

WORLDWIDE SALES OFFICES

USA/Canada 1.877.723.2878

Europe +800.333.222.44/+41.44.943.4380

Middle East +971.4.450.5852

China +86.10.5885.8788-3000

Asia Pacific +852.2669.0828