

RAE PowerPak User's Guide



© Copyright 2009 RAE Systems, Inc.

Ordering Replacement Parts: If you need replacement parts, a list is available online: <http://www.raesystems.com>

RAE PowerPak User's Guide

Contents

1	Safety Instructions	4
1.1	RAE PowerPak Marking.....	5
1.2	Operation Area and Conditions	6
1.3	Instruction For Safe Use	6
1.4	Use In Hazardous Areas.....	7
2	Standard Kit	8
3	General Information.....	8
4	Key Features	9
5	Physical Description	10
6	LCD & LED.....	11
7	LED Status Indicator.....	11
8	LCD Status Information & Error Messages.....	12
9	Installation.....	14
10	Operation Instructions.....	17
11	Connection	18
12	Changing The RAE PowerPak.....	21
13	Charging The RAE PowerPak	24
14	Troubleshooting & Repair	27
14.1	Encapsulated Internal Battery Replacement	27
14.2	Batteries And Proper Battery Disposal	31
15	Specifications	32
Appendix A: Controlled Part Of RAE PowerPak (FTB1000)		
	Manual	33

1 Safety Instructions

WARNINGS

Warning:

This instrument has not been tested in an explosive gas/air atmosphere having an oxygen concentration greater than 21%. Substitution of components may impair suitability for intrinsic safety. Replace encapsulated internal batteries only in non-hazardous locations.

Warning:

Charging of the FTB 1000 by means of mains charger can only be done in safe area and only with RAE Systems Charger P/N F03-3012-000.

Warning:

The internal encapsulated battery units can only be exchanged with the original RAE Systems battery.

RAE PowerPak User's Guide

1.1 RAE PowerPak Marking



The RAE PowerPak is certified according to the IECEx scheme, ATEX and CSA for US and Canada as protected by intrinsic safety.

The product is marked with the following information:

RAE PowerPak

Type FTB1000.

Serial No/barcode: F032XXXXXX

IECEx DNV 09.0003X Ex ia I/IIC T4	 0575  IM1/II 1G Ex ia I/IIC T4 DNV 09 ATEX 55726X	Cl.I Dv 1, Group A,B,C,D T4 Only as to intrinsic safety for use in hazardous loc. Intrinsically safe/ Securite Intrinseque/Exia
---	---	--

Li: 0.1 μ H ; Ci: 0.1 μ F ; Ui: 10 V

Ii : 3.33 A; Pi: 8.8 W; Um: 11V;

Lo: 3.4 μ H; Co: 100 μ F; Uo : 3.6 V

Io: 3.2A; Po: 3.1 W; Lo/Ro: 20.6 μ H/ Ω

-40° C < Tamb < +55° C

Warning: Read User's Manual for Intrinsic Safety Precautions

1.2 Operation Area and Conditions

Hazardous Areas classified by Zones

RAE PowerPak is intended to be used in mines susceptible to firedamp or hazardous areas classified for zone 0, zone 1 or zone 2, within the temperature range of -40° C to +55° C, where gases of explosion groups IIA, IIB or IIC and T4 may be present.

Hazardous Areas classified by Divisions

RAE PowerPak is intended to be used in hazardous areas classified for Class I Div. 1 or 2, within the temperature range of -40° C to +55° C, where gases of explosion groups A, B, C or D and temperature class T4 may be present.

1.3 Instruction For Safe Use

Strictly follow the instructions for safe use. Application of the RAE PowerPak requires full understanding and strict observation of the instructions.

The RAE PowerPak can be charged in hazardous areas by a charger complying with the intrinsically safe input entity parameters.

The RAEPowerPak can be charged outside hazardous areas by a charger complying with the Um parameter.

The internal encapsulated battery units can only be exchanged with the original RAE Systems battery, Part Number: F03-3002-000, in a safe area or with a "hot zone" permit.

The RAEPowerPak can be connected and disconnected inside the hazardous area.

RAE PowerPak User's Guide

1.4 Use In Hazardous Areas

Equipment which is intended for use in explosive atmospheres and which has been assessed and certified according to international regulations may be used only under specified conditions. The components may not be modified in any way.

The appropriate regulations for service and repair must be properly observed during such activities.

FCC Part 15 statement and CE

This device complies with Part15 class B of the FCC rules.

Operation is subject to the following two conditions: (1) This device may not cause harmful interference, and (2) this device must accept any interference received, including interference that may cause undesired operation.

RAE PowerPak User's Guide

2 Standard Kit

RAE PowerPak (FTB1000), as specified with two or four encapsulated internal batteries.

Cable for connecting MeshGuard to RAE PowerPak: D01-3003-000

3 General Information

The RAE PowerPak (FTB-1000) is an intrinsically safe rechargeable battery power source for use with a MeshGuard EC or MeshGuard LEL monitor or MeshGuard Router or any other equipment with matching entity parameters.

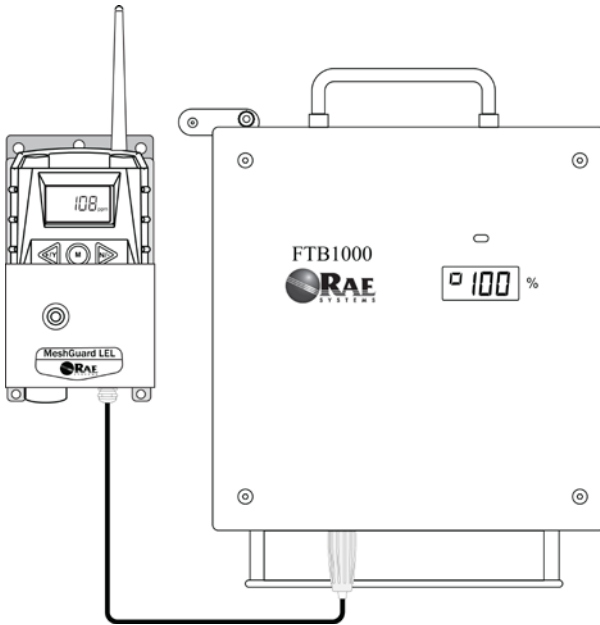

MeshGuard LEL and RAE PowerPak

4 Key Features

- Up to 4 months continuous operation before recharging, when it contains four encapsulated internal batteries and is used with a MeshGuard (4 months), MeshGuard LEL (25 days), or MeshGuard Router (1.5 months)
- Rugged stainless-steel enclosure
- Very low-cost installation – no hardwiring involved
- Very little maintenance or monitoring
- Large, easy-to-read continuous display of power percentage and charging/error messages
- Bright 3-color status LED
- Simple operation without switches or controls
- IP-65 rated for outdoor use in harsh environments
- Unit can be replaced in hazardous location

5 Physical Description

Front View

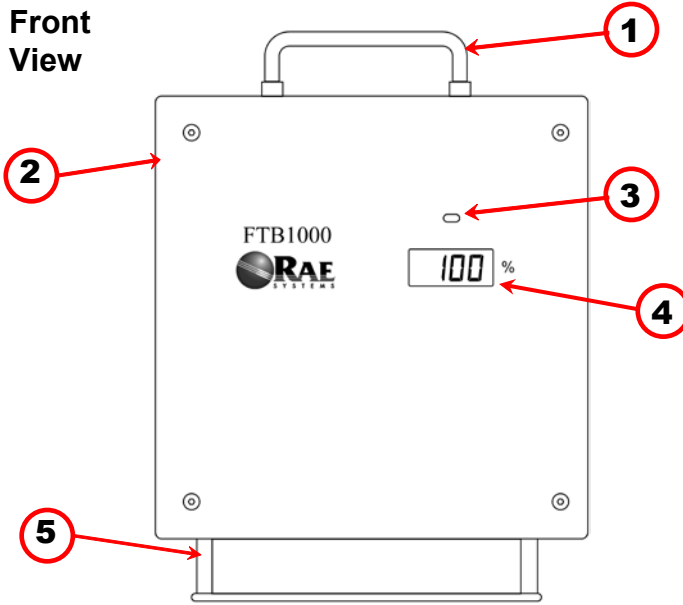

Bottom View

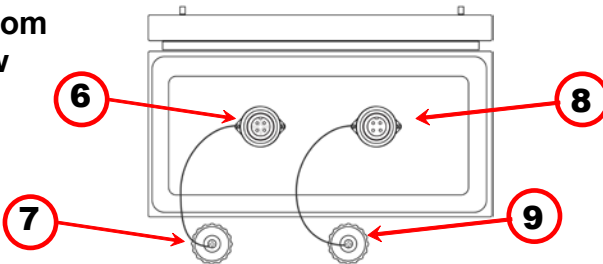

1	Carrying handle
2	Stainless steel enclosure
3	Status LED
4	Status LCD
5	Protective bezel for connections
6	Power output port to MeshGuard
7	Power output dust cap
8	Power input from charger
9	Power input dust cap

RAE PowerPak User's Guide

6 LCD & LED

The RAE PowerPak has a single LED and an LCD that indicates charge, and in the case of errors any messages.

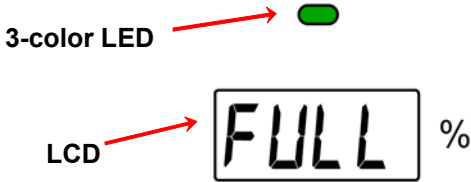

7 LED Status Indicator

The LED glows red, orange, or green, depending on different status alerts it is conveying.

Color	Indication	Related LCD Message
Green	Battery (or batteries) fully charged.	LCD says "FULL"
Red	Battery (or batteries) charging.	LCD says "CHRG" (charging)
Orange	Indicates an error. Check the LCD for more information.	LCD shows error code beginning with the letters "Er" followed by two digits indicating the type of error.

8 LCD Status Information & Error Messages

Error codes may appear in the LCD, indicating battery or fuse conditions, as well as temperatures outside the normal operating range.

Error Code	Message
Er01	Battery 1 voltage too low
Er02	Battery 2 voltage too low
Er03	Battery 3 voltage too low
Er04	Battery 4 voltage too low
Er05	Battery 1 voltage too high
Er06	Battery 2 voltage too high
Er07	Battery 3 voltage too high
Er08	Battery 4 voltage too high
Er09	Battery 1 temperature too low
Er10	Battery 2 temperature too low
Er11	Battery 3 temperature too low
Er12	Battery 4 temperature too low
Er13	Wrong battery type
Er14	Wrong charger
Er15	Fuse break

Error Code	Explanation & Solution
Er01 to Er04:	The battery is not charging to full capacity. It may need to be replaced.
Er05 to Er08:	The battery is overcharging, but does not send too much power to the MeshGuard, since it has overvoltage protection.
Er09 to Er12:	The battery is being charged in a location where the temperature is below 0° C (32° F), and therefore is charging slowly. The only problem this presents is that the battery cannot be fast-charged.

RAE PowerPak User's Guide

Er13:	The wrong type of battery has been placed in one of the four slots. Replace it with the correct type.
Er14:	The wrong type of charger is being used. The correct RAE Systems charger (part number F03-3014-000) identifies itself to the RAE PowerPak.
Er15:	An internal fuse has been blown. Fuses on the main circuit board cannot be replaced. The main circuit board must be replaced. Contact RAE Systems service.

The number of batteries is indicated by the number of segments showing in the left side of the display.

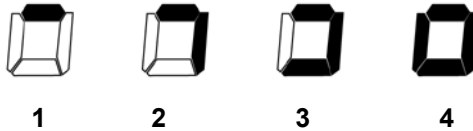

These segments correspond to the battery locations (the enclosure is shown with its front cover removed):

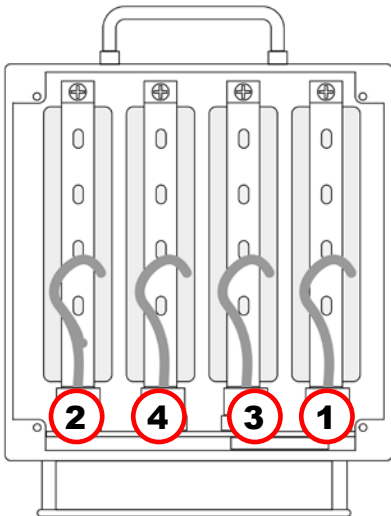

0 75

Note: The percentage of battery charge is relative to the capacity of the entire number of batteries. If there is one battery and the reading is 75%, that means 75% of the one battery's capacity. If there are multiple batteries, 75% means 75% of the total combined capacity. Always refer to the number of segments indicating the total number of batteries.

RAE PowerPak User's Guide

9 Installation

The RAE PowerPak is designed to be located close to a detector such as a MeshGuard, MeshGuard LEL or MeshGuard Router. To accommodate this, and to ensure security, both are mounted on a steel plate, which can be attached to a wall or other flat vertical surface.

Before attaching the steel plate to a surface, you should attach the metal enclosure for the MeshGuard to the plate.

1. Place the MeshGuard in the steel enclosure.
2. Turn the plate and MeshGuard over.
3. Line up the hole on the back of the MeshGuard with the hole on the plate.
4. Insert an M4x10 screw through a flat washer and locking washer, and tighten the MeshGuard's steel enclosure to the plate.

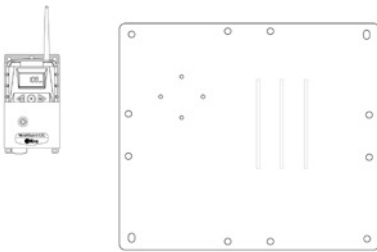

Front view

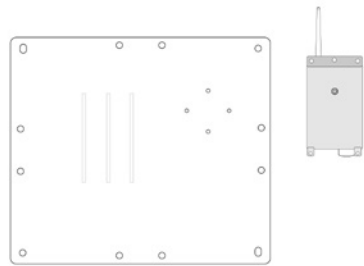

Rear view

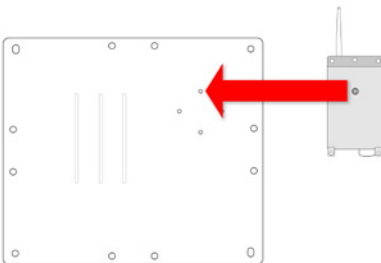

Align the holes

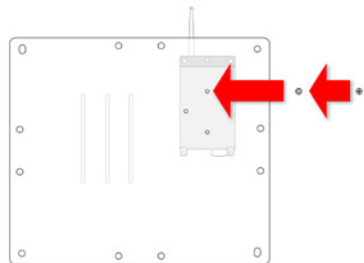

Insert screw through flat and locking washers and secure

RAE PowerPak User's Guide

Secure the plate to a wall or other solid, flat surface by using M8-size screws with flat washers and locking washers, following this diagram. At a minimum, use four screws at the corners. (The MeshGuard has been removed from the drawing for simplicity.)

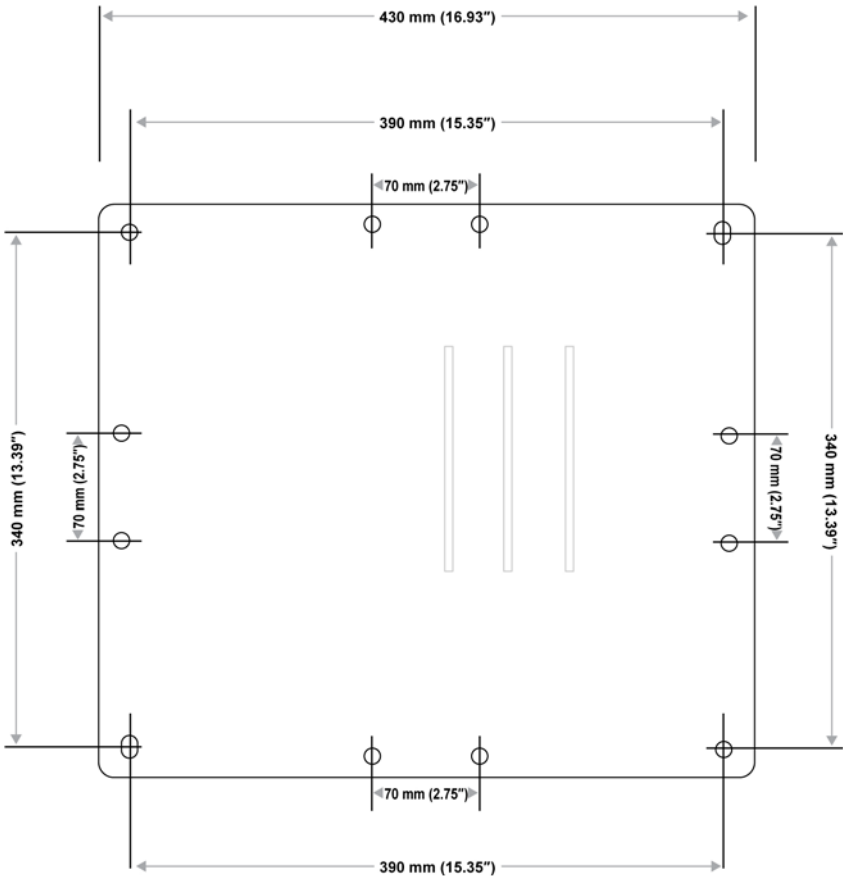

IMPORTANT!

Allow sufficient clearance around the mounting plate to accommodate replacing sensor and lifting and removing BatteryPak.

RAE PowerPak User's Guide

Next mount the RAE PowerPak onto the steel plate.

Note: Make sure the RAE PowerPak has been fully charged before installation.

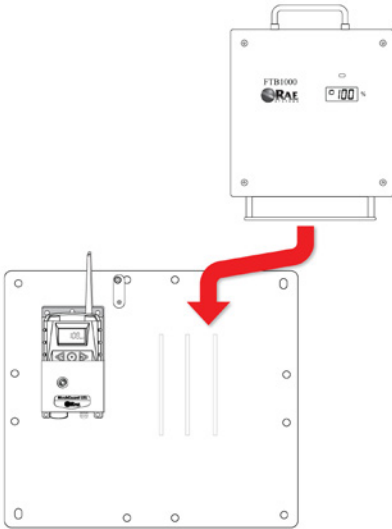

Align the RAE PowerPak with the rails on the metal plate

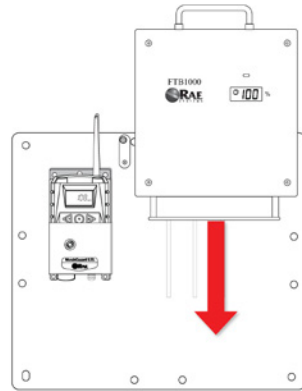

Slide the RAE PowerPak down until it stops

Use the latch to lock the RAE PowerPak in place:

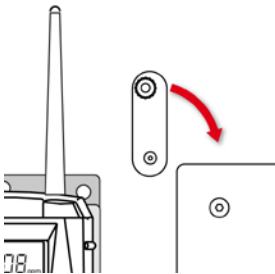

Flip the latch down to the horizontal position

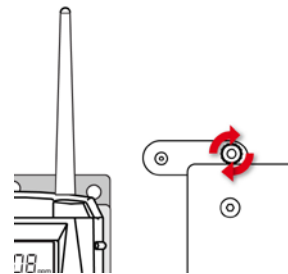

Turn the screw until it is finger-tight – do not overtighten or use tools

RAE PowerPak User's Guide

10 Operation Instructions

The FTB 1000 Power Pack is only to be used with RAE Systems products whose entity parameters match the entity parameters of the RAE PowerPak.

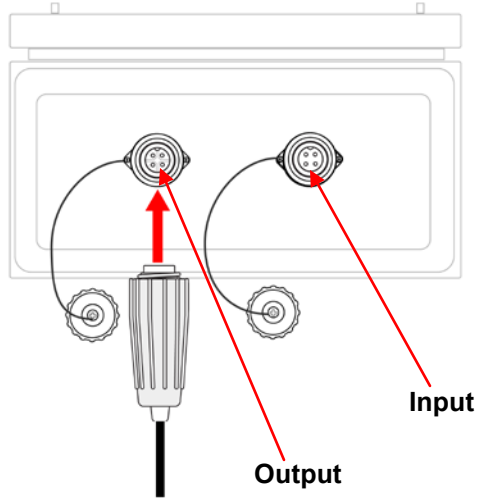

Fig. 1 Connections

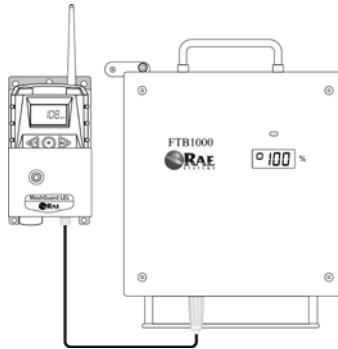

Fig. 2 RAE PowerPak connected to the MeshGuard.

The RAE PowerPak can be connected and disconnected inside the hazardous area.

RAE PowerPak User's Guide

11 Connection

Note: The following steps must be performed outside the hazardous area or with a “hot zone” permit.

Now connect the cable between the RAE PowerPak and the MeshGuard.

With the MeshGuard or MeshGuard LEL securely in its housing, you can remove the cover over the battery compartment so that you can replace the internal battery in the MeshGuard. Use the sensor and battery removal tool as shown.

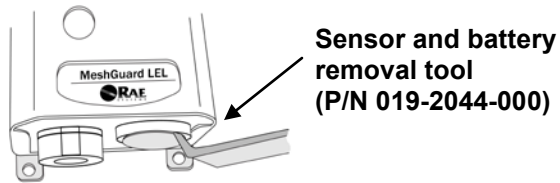

The connector from the RAE PowerPak screws into the MeshGuard's battery compartment. Bottom views of the MeshGuard in its steel enclosure are shown in the procedure below.

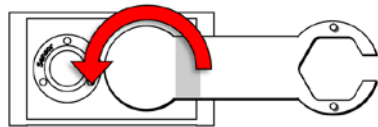
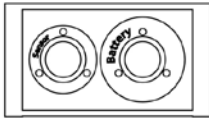

1. Remove battery cover with the 3-pin end of the sensor and battery removal tool by turning counterclockwise.

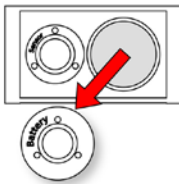

2. Lift off the cover.

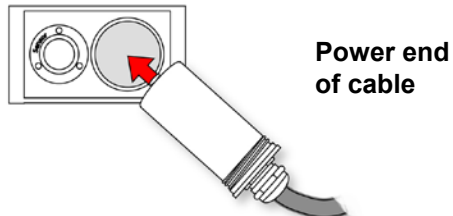

3. Insert the power end of the cable connected to the Power Pack.

RAE PowerPak User's Guide

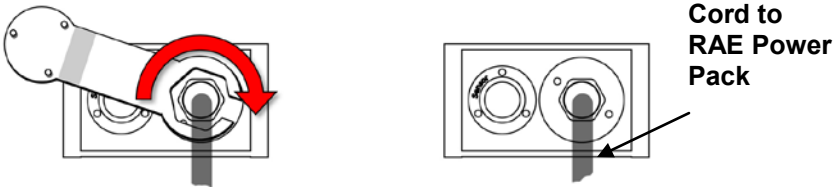

4. Use the open hex end of the wrench, and with both pins mated with the two holes on the power end, tighten by turning clockwise until it is snug. Do not overtighten.

On the bottom of the RAE PowerPak are two dust caps that are screwed onto the connectors:

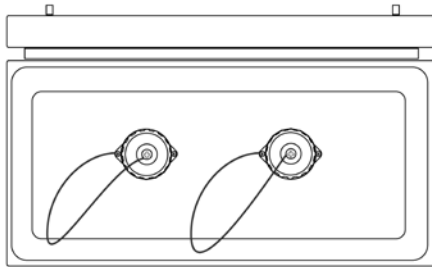

Unscrew the one on the left by turning it counterclockwise. When it is removed, you see the four pins of the connector.

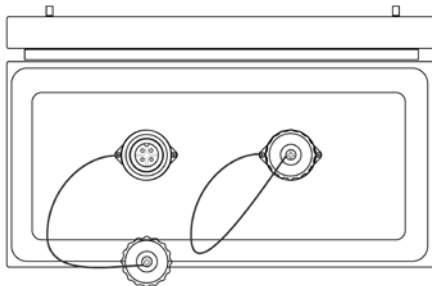

RAE PowerPak User's Guide

Screw the end of the connecting cable to the port on the bottom of the RAE PowerPak. Do not use tools or overtighten.

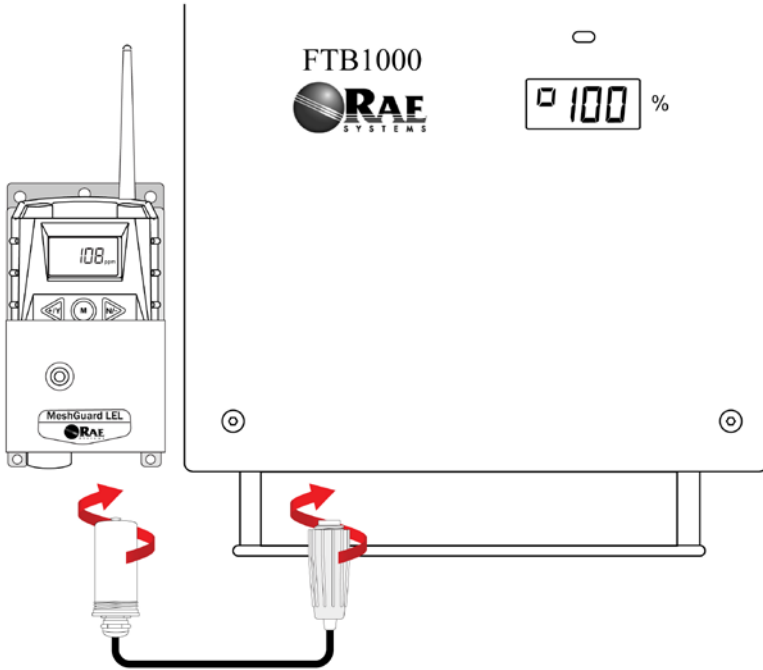

12 Changing The RAE PowerPak

1. Unscrew the battery connector from the RAE PowerPak.

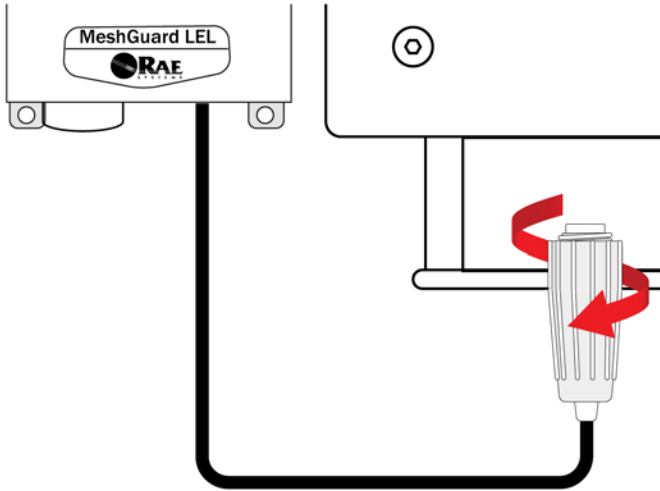

2. Loosen the safety screw holding the battery latch.

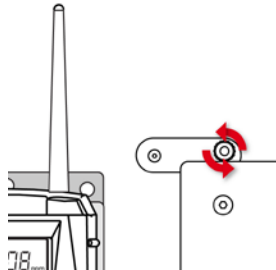

RAE PowerPak User's Guide

3. Raise the latch.

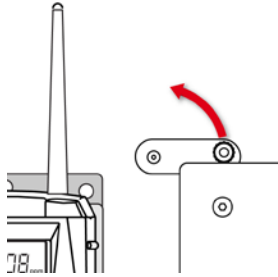

4. Lift up the battery and slide it off the steel plate.

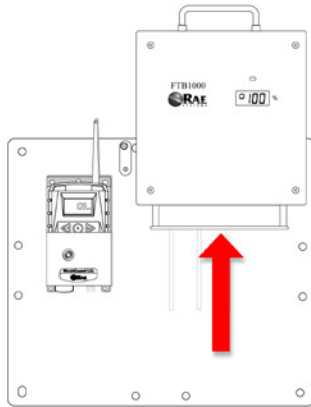

RAE PowerPak User's Guide

5. Mount a fully charged RAE PowerPak on the mounting bracket.

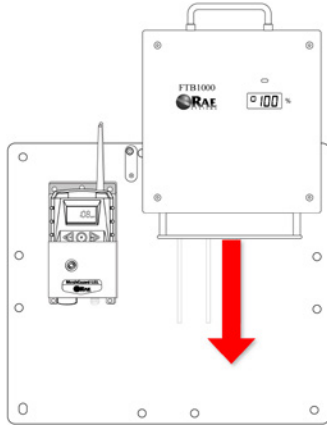

6. Flip the latch down.

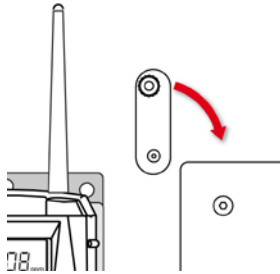

7. Tighten the safety screw.

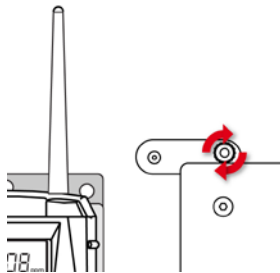

RAE PowerPak User's Guide

8. Connect the MeshGuard LEL to the battery.

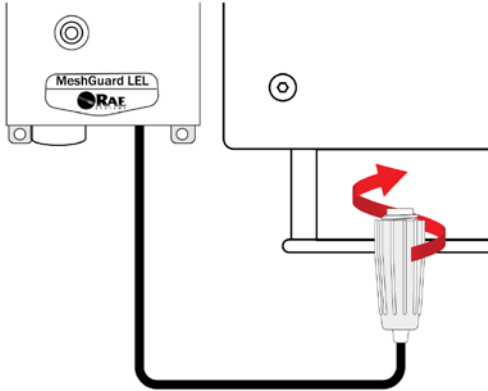

9. Turn on the MeshGuard LEL.

13 Charging The RAE PowerPak

Before using the RAE PowerPak and whenever the RAE PowerPak shows a low-power reading (10% or less), you should charge it in a safe location.

1. If the RAE PowerPak is currently in service and is attached to a MeshGuard, follow the instructions for removing it, on page 21.
2. Remove the cap over the charging port on the bottom of the RAE PowerPak by unscrewing it.

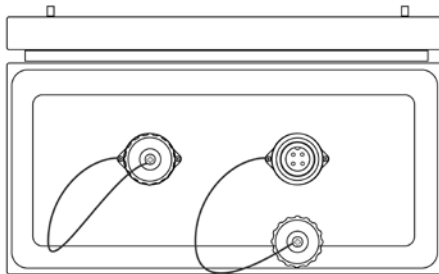

RAE PowerPak User's Guide

3. In a safe location, connect the charging cable between the RAE PowerPak and the Charger and connect the AC mains cord from the Charger to an AC power plug.

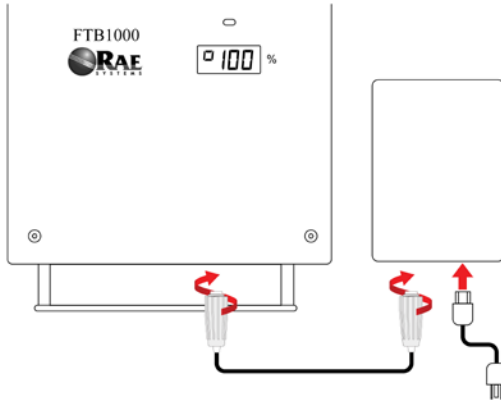

4. The LED above the display should glow red and the display should say “CHRG.” If not, check your connections and the AC outlet.



CHRG %

5. When the RAE PowerPak is fully charged, the LED glows green and the display says “Full.”



FULL %

6. Disconnect the AC mains cord from the AC power outlet.

RAE PowerPak User's Guide

7. Disconnect the Charger from the RAE PowerPak.
8. Screw the cap back on over the charging port on the bottom of the RAE PowerPak.
9. Place the RAE PowerPak on the steel mounting plate (detailed instructions are shown on page 14).
10. Follow the instructions on page 17 to reconnect the RAE PowerPak to the MeshGuard.

14 Troubleshooting & Repair

The RAE PowerPak is designed to be trouble-free and require no maintenance. However, if you see the status LED glow orange and an error message in the display, refer to the error message table on page 12 and take the suggested action.

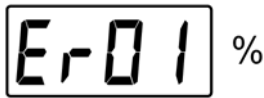

14.1 Encapsulated Internal Battery Replacement

In the unlikely event that one of the encapsulated internal batteries needs replacement, it is easy to replace them in the RAE PowerPak. Follow these steps, and only replace an encapsulated internal battery with a RAE Systems model with the same part number (F03-3002-000).

WARNING!

Only open the RAE PowerPak enclosure and change or charge encapsulated internal batteries in a non-hazardous location or with a “hot zone” permit.

RAE PowerPak User's Guide

1. Unscrew the four screws on the front of the enclosure.



2. Disconnect the battery's power jumper from the main printed circuit board.

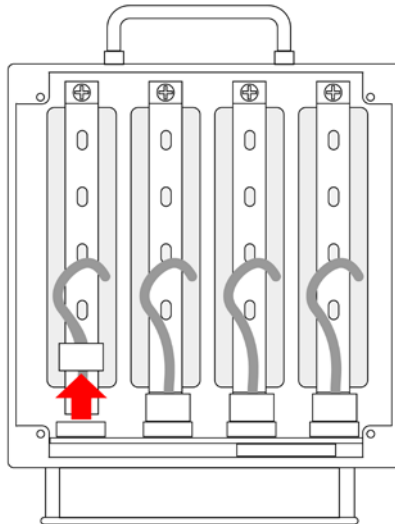

RAE PowerPak User's Guide

3. Remove the screws at both ends of the battery. These attach the bracket that holds the battery in place.

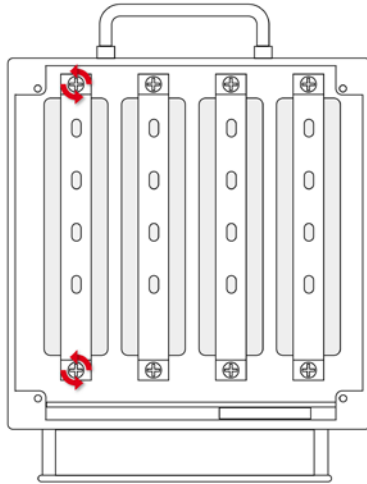

4. Lift out the bracket and the battery.

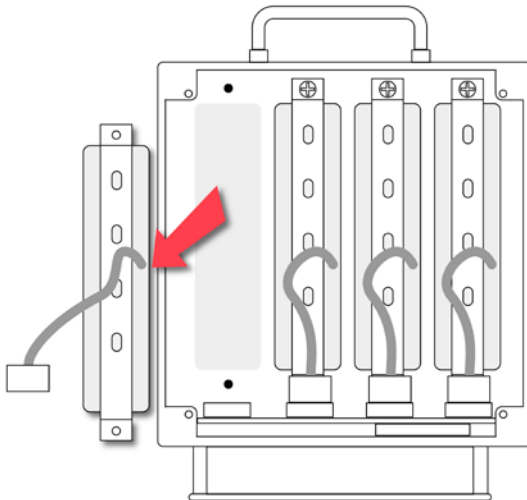

RAE PowerPak User's Guide

5. Insert a new battery and the bracket into the enclosure.

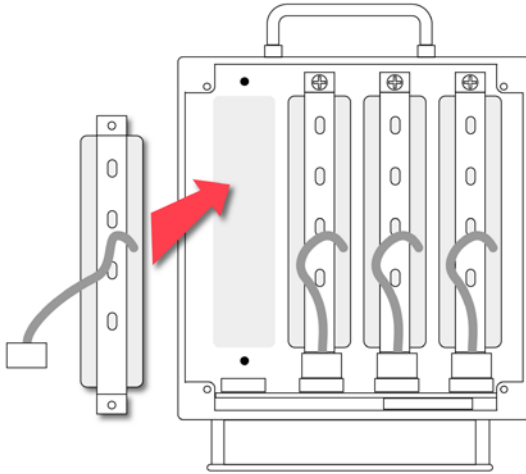

6. Replace the two screws and tighten them with a screwdriver.

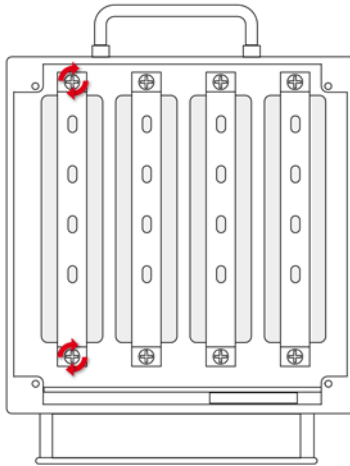

Before replacing the front cover, check the display. If it is not working, then the ribbon cable between the display and the main circuit board might have become disconnected. Make sure it is firmly connected to the printed circuit board and to the display module.

RAE PowerPak User's Guide

The display should indicate the correct number of batteries. If not, check that the connector between the battery and the circuit board is firmly connected.

7. Once everything checks out, replace the front cover and tighten the screws.



14.2 Batteries And Proper Battery Disposal

This product may contain one or more sealed lead-acid, nickel-cadmium (NiCd), nickel-metal hydride (NiMH), lithium (Li), or lithium-ion batteries. Specific battery information is given in this user guide. Batteries must be recycled or disposed of properly.



This symbol (crossed-out wheeled bin) indicates separate collection of waste electrical and electronic equipment in the EU countries. Please do not throw the equipment into the domestic refuse. Please use the return and collection systems available in your country for the disposal of this product.

15 Specifications

Display	Customized LCD and red/orange/green LED
Dimensions	36.2 cm x 26 cm x 14.6 cm (14.25" H x 10.25" W x 5.75" D)
Weight	15 kg (33 lbs) with four internal batteries
Package	IP-65
Output Voltage	3.3V±0.1V
Maximum Output Current	0.33A
Capacity	Two internal battery units: 26Ah Four internal battery units: 52Ah
Mounting	Stainless-steel wall-mount plate
Options	Stainless-steel or zinc steel version

Appendix A: Controlled Part Of RAE PowerPak (FTB1000) Manual

The scope of this document is to control the safety-related parts of the manual, which cannot be changed without permission from the competent body.

WARNINGS

Warning:

This instrument has not been tested in an explosive gas/air atmosphere having an oxygen concentration greater than 21%. Substitution of components may impair suitability for intrinsic safety. Replace encapsulated internal batteries only in non-hazardous locations.

Warning:

Charging of the FTB 1000 by means of mains charger can only be done in safe area and only with RAE Systems Charger P/N F03-3012-000.

Warning:

The internal encapsulated battery units can only be exchanged with the original RAE Systems battery.

RAE PowerPak User's Guide

RAE PowerPak Marking



The RAE PowerPak is certified according to the IECEx scheme, ATEX and CSA for US and Canada as protected by intrinsic safety.

The product is marked with the following information:

RAE PowerPak

Type FTB1000.

Serial No/barcode: F032XXXXXX

IECEx DNV 09.0003X Ex ia I/IIC T4	 0575  IM1/II 1G Ex ia I/IIC T4 DNV 09 ATEX 55726X	CI.I Dv 1, Group A,B,C,D T4 Only as to intrinsic safety for use in hazardous loc. Intrinsically safe/ Securite Intrinseque/Exia
---	---	--

Li: 0.1 μ H ; Ci: 0.1 μ F ; Ui: 10 V
Ii : 3.33 A; Pi: 8.8 W; Um: 11V;
Lo: 3.4 μ H; Co: 100 μ F; Uo : 3.6 V
Io: 3.2A; Po: 3.1 W; Lo/Ro: 20.6 μ H/ Ω

-40° C < Tamb < +55° C

Warning: Read User's Manual for Intrinsic Safety Precautions.

Operation Area and Conditions

Hazardous Areas classified by Zones

RAE PowerPak is intended to be used in mines susceptible to firedamp or hazardous areas classified for zone 0, zone 1 or zone 2, within the temperature range of -40° C to +55° C, where gases of explosion groups IIA, IIB or IIC and T4 may be present.

Hazardous Areas classified by Divisions

RAE PowerPak is intended to be used in hazardous areas classified for Class I Div. 1 or 2, within the temperature range of -40° C to +55° C, where gases of explosion groups A, B, C or D and temperature class T4 may be present.

Instruction For Safe Use

Strictly follow the instructions for safe use. Application of the RAE PowerPak requires full understanding and strict observation of the instructions.

The RAE PowerPak can be charged in hazardous areas by a charger complying with the intrinsically safe input entity parameters.

The RAEPowerPak can be charged outside hazardous areas by a charger complying with the Um parameter.

The internal encapsulated battery units can only be exchanged with the original RAE Systems battery, Part Number: F03-3002-000, in a safe area or with a "hot zone" permit.

The RAEPowerPak can be connected and disconnected inside the hazardous area.

Use In Hazardous Areas

Equipment which is intended for use in explosive atmospheres and which has been assessed and certified according to international regulations may be used only under specified conditions. The components may not be modified in any way.

The appropriate regulations for service and repair must be properly observed during such activities.



RAE Systems by Honeywell
World Headquarters
3775 N. First St.
San Jose, CA 95134-1708 USA
Phone: 408.952.8200
Toll-Free: 888.723.4800
Fax: 408.952.8480

E-mail (sales support): raesales@raesystems.com
E-mail (technical support): tech@raesystems.com
Web Site: www.raesystems.com

RAE Systems Europe

Kristinehøj 23A, DK-2770 Kastrup • Denmark
Tel: +45.8652.5155 • Fax: +45.8652.5177

RAE Systems (Hong Kong) Ltd.

Units 1516-18, 15/F, Delta House, 3 On Yiu Street
Shatin, N.T. Hong Kong
Web: www.raesystems.cn • Email: asiasales@raesystems.com
Phone: +852.2669.0828

RAE Systems Middle East

LOB 7, Ground Floor, Office 19, Jebel Ali Free Zone
Dubai, United Arab Emirates
Email: mesales@raesystems.com • Phone: +971.4.887.5562

Rev. A
July 2009
P/N F03-4001-000